



Badger Meter

Recordall® Turbo Series Meters

Models 160 (1-1/2"), 200 (2"), 450 (3"), 1000 (4"),
2000 (6"), 3500 (8"), 5500 (10"), & 6200 (12");
NSF/ANSI Standards 61 and 372 Certified

DESCRIPTION

Recordall Turbo Series meters meet or exceed the most recent revision of AWWA Standard C701 Class II Standards and are available in a lead-free bronze alloy for sizes 1-1/2" through 10" and cast iron for 12" meters. Turbo Series meters comply with the lead-free provisions of the Safe Drinking Water Act. Sizes 1-1/2" through 10" meters are also certified to NSF/ANSI Standards 61 and 372 (Trade Designation: Turbo Series LL-NS) and carry the NSF-61 mark on the housing. All components of the lead-free alloy meter (housing, measuring element, seals and so on) comprise the certified system.

Models 160 through 6200 are designed for 1-1/2" through 12" applications. These meters feature:

- Direct coupled turbine based on an exclusive "floating rotor" design that reduces bearing friction—and associated wear and tear.
- Low pressure loss for improved system efficiency.
- Exceptional registration accuracy across low flow rate, normal operating flow rate and maximum continuous operation flow.
- Permanently sealed, tamper-resistant register or encoder.
- Integral strainer option for sizes 1-1/2" through 4" help protect your system from damaging debris and related downtime.
- Meters and encoders are compatible with Badger Meter AMR/AMI meter reading systems and other approved reading technologies.

Applications: Recordall Turbo Series meters are designed for cold water, commercial and industrial applications where flows are consistent medium to high flows. Applications include hotels, apartment buildings, irrigations centers and manufacturing and processing plants. Turbo Series meters help reduce day-to-day maintenance costs while delivering accurate and efficient performance.

Operation & Performance: Direct magnetic drive is achieved when the magnet carrier is driven by a gear train coupled to the rotor. The gear train consists of two sets of gears connected by a vertical transmission shaft. One gear set is at the magnet carrier, the other is a worm gear set at the rotor shaft. When water flows into the Turbo Series meter measuring element, it contacts the multi-vaned rotor. The resulting rotor rotation is then transmitted by magnetic coupling to a sealed register or encoder. The direct magnetic drive is built to provide a reliable meter-to-registration coupling.



Tamper-Proof Features: Unauthorized removal of the register or encoder is inhibited by the option of a tamper detection seal wire screw, TORX® tamper-resistant seal screw or the proprietary tamper-resistant keyed seal screw. Each can be installed at the meter site or at the factory.

Construction: The Recordall Turbo Series meter is constructed in compliance with ANSI and AWWA C701 standards. It consists of the following basic components: meter housing, interchangeable, unitized measuring element and permanently sealed direct reading registers or encoders.

The measuring element consists of the transmission coupling, rotor, inlet and outlet straightening vanes with nose cones, and calibration ring assembly. The unique inlet and outlet straightening vanes minimize swirl from piping arrangements upstream as well as downstream.

A strainer is recommended to help ensure optimal flow conditioning and protection for the measuring element. An integral strainer is available as an option for 1-1/2" through 4" meter sizes. The stainless steel strainer is built into the inlet end and includes a removable cover plate to permit easy access for routine cleaning. External strainers are available in sizes 2" through 12".

To simplify maintenance, the registers or encoders and measuring elements can be removed without removing the meter housing. Interchangeability of certain parts between meters also minimizes spare parts inventory investment.

Meter Installation: The meter is designed for installations where flow is in one direction only. Companion flanges for installation of meters on various pipe types and sizes are available in cast iron or NL bronze as an option. See the Recordall Turbo Series Meters User Manual for specific instructions.

SPECIFICATIONS

Turbo Series Model	160 1-1/2" (40 mm)	200 2" (50 mm)	450 3" (80 mm)	1000 4" (100 mm)	2000 6" (150 mm)	3500 8" (200 mm)	5500 10" (250 mm)	6200 12" (300 mm)
Meter Flanges AWWA 125 Pound Class	Elliptical	Elliptical or Round	Round	Round	Round	Round	Round	Round AWWA 125 lb class
Typical Operating Range (100% ± 1.5%)	4...200 gpm (0.9...45.4 m ³ /h)	4...310 gpm (0.9...70.4 m ³ /h)	5...550 gpm (1.1...124.9 m ³ /h)	10...1250 gpm (2.3...284 m ³ /hr)	20...2500 gpm (4.5...568 m ³ /h)	30...4500 gpm (6.8...1022 m ³ /h)	50...7000 gpm (11.4...1590 m ³ /h)	90...8800 gpm (20.5...1998 m ³ /h)
Typical Low Flow (95% min.)	2.5 gpm (0.6 m ³ /h)	2.5 gpm (0.6 m ³ /h)	4 gpm (0.9 m ³ /h)	6 gpm (1.4 m ³ /h)	12 gpm (2.7 m ³ /h)	20 gpm (4.5 m ³ /h)	30 gpm (6.8 m ³ /h)	65 gpm (14.8 m ³ /h)
Max. Continuous Flow	160 gpm (36 m ³ /h)	200 gpm (45.4 m ³ /h)	450 gpm (102.2 m ³ /h)	1000 gpm (227.1 m ³ /h)	2000 gpm (454 m ³ /h)	3500 gpm (795 m ³ /h)	5500 gpm (1250 m ³ /h)	6200 gpm (1408 m ³ /h)
Maximum Intermittent Flow	200 gpm (45.4 m ³ /h)	310 gpm (70.4 m ³ /h)	550 gpm (124.9 m ³ /h)	1250 gpm (284 m ³ /h)	2500 gpm (568 m ³ /h)	4500 gpm (1022 m ³ /h)	7000 gpm (1590 m ³ /h)	8800 gpm (1988 m ³ /h)
Pressure Loss at Max. Continuous Flow	3.8 psi (0.26 bar)	3.1 psi (0.21 bar)	1.8 psi (0.12 bar)	7.3 psi (0.50 bar)	4.8 psi (0.33 bar)	2.5 psi (0.17 bar)	1.6 psi (0.11 bar)	0.8 psi (0.05 bar)
Pressure Loss at Max. Continuous Flow: With Integral Strainer	9.9 psi (0.68 bar)	8.3 psi (0.57 bar)	5 psi (0.43 bar)	17.8 psi (1.2 bar)	—			
Max. Operating Pressure	150 psi (10 bar)							
Max. Operating Temperature	120° F (49° C)							
Optional Integral Strainer	Built into inlet end. Removable cover plate permits access to strainer for cleaning.				—			
Optional External Strainer	— Available for Models 200, 450, 1000, 2000, 3500, 5500 and 6200.							
Test Plug	Standard with integral strainer; optional for other models.				Optional for Models 2000 and 3500.		—	

MATERIALS

Meter Housing	Lead-free alloy (EXCEPTION: Model 6200 meter housing is blue epoxy-coated cast iron)
Turbo Head	Lead-free alloy
Nose Cone & Straightening Vanes	Thermoplastic
Rotor	Thermoplastic
Rotor Radial Bearings	Lubricated thermoplastic
Rotor Thruster Bearing	Sapphire jewels
Rotor Bearing Pivots	Passivated 316 stainless steel
Calibration Mechanism	Stainless steel & thermoplastic
Magnet	Ceramic
Trim	Stainless steel
Register Housing & Cover	Thermoplastic or bronze
Optional Strainer and Trim	Stainless steel

REGISTERS / ENCODERS

Standard—Sweep-Hand Registration

The standard register is a straight-reading, permanently sealed magnetic drive register. Dirt, moisture, tampering and lens fogging problems are eliminated. The register has a six-odometer wheel totalization display, 360° test circle with center sweep hand, and flow finder to detect leaks. Register gearing is made of self-lubricating engineered polymer, which minimizes friction and provides long life. The multi-position register simplifies meter installation and reading. The high-flow register capacity for the 1-1/2", 2", 3" and 4" meters is 100,000,000 gallons (10,000,000 ft³, 1,000,000 m³). The high-flow register capacity for the 6", 8", and 10" meters is 1,000,000,000 gallons (100,000,000 ft³, 10,000,000 m³). The high-flow register capacity for the 12" meter is 10,000,000,000 gallons (1,000,000,000 ft³, 10,000,000 m³).

Registers for 1-1/2", 2", 3" and 4" Meters

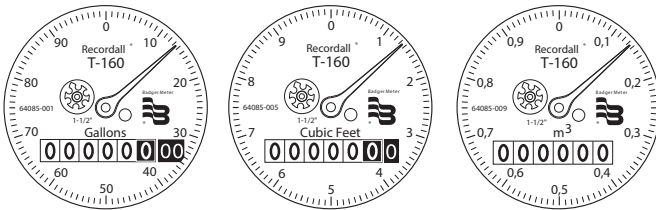

Sweep Hand Revolution

Meter Model	Gallon	Cubic Feet	Cubic Meter
160	100	10	1
200	100	10	1
450	100	10	1
1000	100	10	1

Registers for 6", 8" and 10" Meters

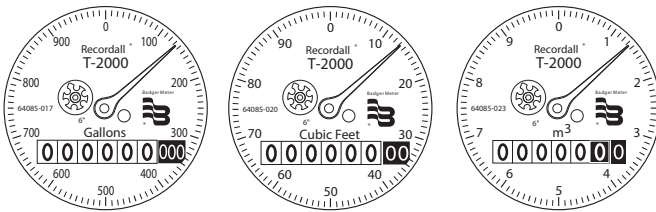

Sweep Hand Revolution

Meter Model	Gallon	Cubic Feet	Cubic Meter
2000	1000	100	10
3500	1000	100	10
5500	1000	100	10

Registers for 12" Meters

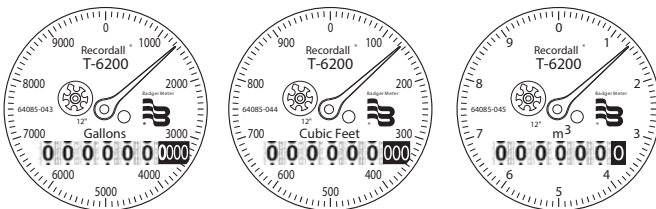

Sweep Hand Revolution

Meter Model	Gallon	Cubic Feet	Cubic Meter
6200	10000	1000	10

Optional—Encoders for AMR/AMI Reading Solutions

AMR/AMI solutions are available for all Recordall Disc Series meters. All reading options can be removed from the meter without disrupting water service. Badger Meter encoders provide years of reliable, accurate readings for a variety of applications and are also available pre-wired to Badger Meter approved AMR/AMI solutions. See details at www.badgermeter.com.

PHYSICAL DIMENSIONS OF METERS WITHOUT STRAINER

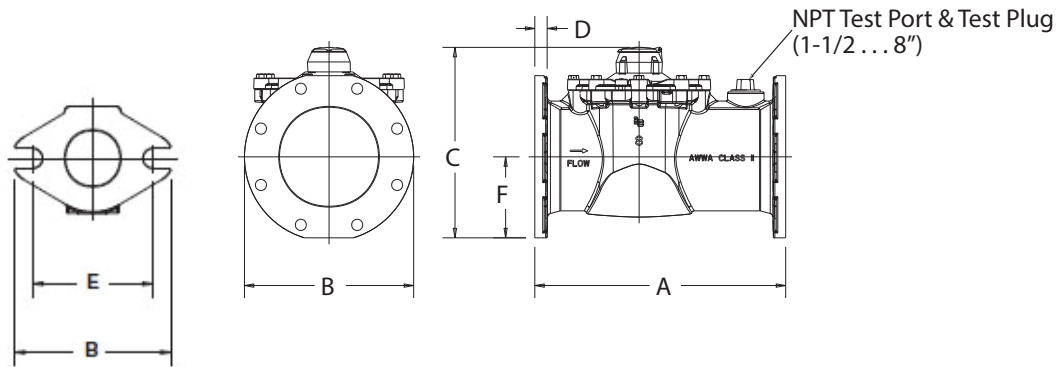

Figure 1: Sample Illustration from 8" Model 3500

Turbo Series Model	160	200	200	450	1000	2000	3500	5500	6200
Meter Flanges	1-1/2" Elliptical	2" Elliptical	2" Round	3" Round	4" Round	6" Round	8" Round	10" Round	12" Round
Meter & Pipe Size	1-1/2" (40 mm)	2" (50 mm)	2" (50 mm)	3" (80 mm)	4" (100 mm)	6" (150 mm)	8" (200 mm)	10" (250 mm)	12" (300 mm)
Net Weight	14.3 lb (6.5 kg)	14.9 lb (6.8 kg)	17.4 lb (7.9 kg)	31 lb (14.1 kg)	40 lb (18.1 kg)	77 lb (35 kg)	123 lb (55.7 kg)	210 lb (95.3 kg)	262 lb (118.8 kg)
Shipping Weight	16.8 lb (7.6 kg)	16.4 lb (7.4 kg)	18.9 lb (8.6 kg)	34 lb (15.4 kg)	45 lb (20.4 kg)	89 lb (40.4 kg)	147 lb (66.6 kg)	235 lb (106.6 kg)	286 lb (129.7 kg)
Qty. of Bolts	2	2	4	4	8	8	8	12	12
NPT Test Port & Test Plug (optional)	1" (25.4 mm)	1-1/2" (40 mm)	1-1/2" (40 mm)	2" (50 mm)	2" (50 mm)	2" (50 mm)	2" (50 mm)	—	—
Length (A)	13" (330 mm)	10" (254 mm)	10" (254 mm)	12" (305 mm)	14" (356 mm)	18" (457 mm)	20" (508 mm)	26" (660.4 mm)	19-11/16" (500 mm)
Width (B)	5-7/32" (133 mm)	5-27/32" (148 mm)	6" (152 mm)	7-1/2" (191 mm)	9" (229 mm)	11" (280 mm)	13-1/2" (343 mm)	16" (406.4 mm)	19" (482 mm)
Height (C)	6-9/32" (159 mm)	6-1/2" (165 mm)	7-3/32" (180 mm)	8-11/16" (220 mm)	9-21/32" (245 mm)	13-5/16" (338 mm)	15-3/16" (385 mm)	17-15/32" (443 mm)	19-11/16" (500 mm)
Flange (D)	51/64" (20 mm)	25/32" (20 mm)	5/8" (16 mm)	3/4" (19 mm)	13/16" (21 mm)	7/8" (22 mm)	1" (25 mm)	1-1/16" (27 mm)	1.26" (32 mm)
Bolt Circle (E)	4" (102 mm)	4-1/2" (114 mm)	4-3/4" (121 mm)	6" (152 mm)	7-1/2" (191 mm)	9-1/2" (241 mm)	11-3/4" (298 mm)	14-1/4" (362 mm)	17" (432 mm)
Centerline (F)	1-27/32" (47 mm)	2-1/16" (52 mm)	2-5/8" (67 mm)	3-11/32" (85 mm)	4-5/16" (109 mm)	5-1/4" (133 mm)	6-3/8" (162 mm)	7-7/8" (199.4 mm)	8-7/8" (226 mm)

PHYSICAL DIMENSIONS OF METERS WITH INTEGRAL STRAINER

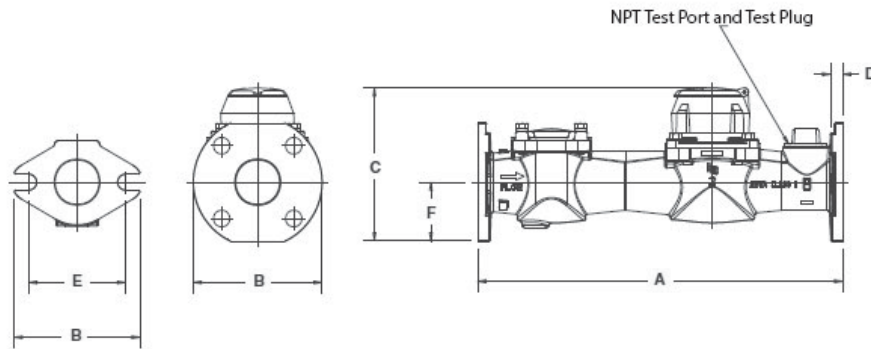
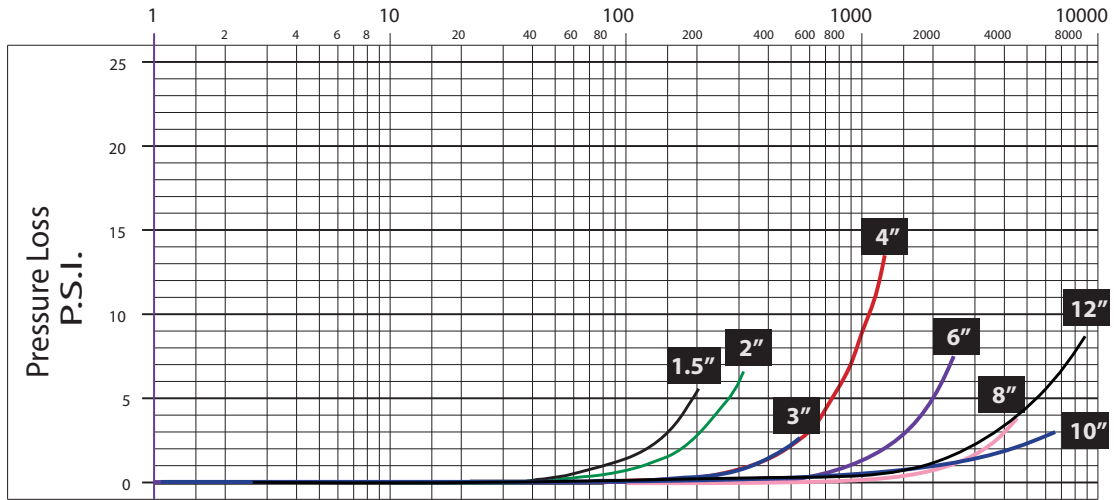

Figure 2: Physical dimensions

Turbo Series Model	160	200	200	450	1000
Meter Flanges	Elliptical	Elliptical	Round	Round	Round
Meter & Pipe Size	1-1/2" (40 mm)	2" (50 mm)	2" (50 mm)	3" (80 mm)	4" (100 mm)
Net Weight	14.3 lb (6.5 kg)	24 lb (11 kg)	26 lb (12 kg)	49 lb (22 kg)	60 lb (27.22 kg)
Shipping Weight	16.8 lb (7.6 kg)	28 lb (13 kg)	30 lb (14 kg)	55 lb (25 kg)	70 lb (31.75 kg)
Number of Bolts	2	2	4	4	8
NPT Test Port & Test Plug (Standard)	1" (25.4 mm)	1-1/2" (40 mm)	1-1/2" (40 mm)	2" (50 mm)	2" (50 mm)
Length (A)	13" (330 mm)	17" (432 mm)	17" (432 mm)	19" (483 mm)	23" (584 mm)
Width (B)	5-7/32" (133 mm)	5-27/32" (148 mm)	6" (152 mm)	7-1/2" (191 mm)	9" (229 mm)
Height (C)	6-9/32" (159 mm)	6-1/2" (165 mm)	7-3/32" (180 mm)	8-15/16" (227 mm)	9-21/32" (245 mm)
Flange (D)	51/64" (20 mm)	27/32" (47 mm)	5/8" (16 mm)	27/32" (21 mm)	13/16" (21 mm)
Bolt Circle (E)	4" (102 mm)	4-1/2" (114 mm)	4-3/4" (121 mm)	6" (152 mm)	7-1/2" (191 mm)
Centerline (F)	1-27/32" (47 mm)	2-1/16" (52 mm)	2-5/8" (67 mm)	3-19/32" (91 mm)	4-5/16" (109 mm)

PRESSURE LOSS CHART FOR METERS WITHOUT STRAINER

Rate of flow in gallons per minute (gpm)



PRESSURE LOSS CHART FOR METERS WITH INTEGRAL STRAINER

Rate of flow in gallons per minute (gpm)

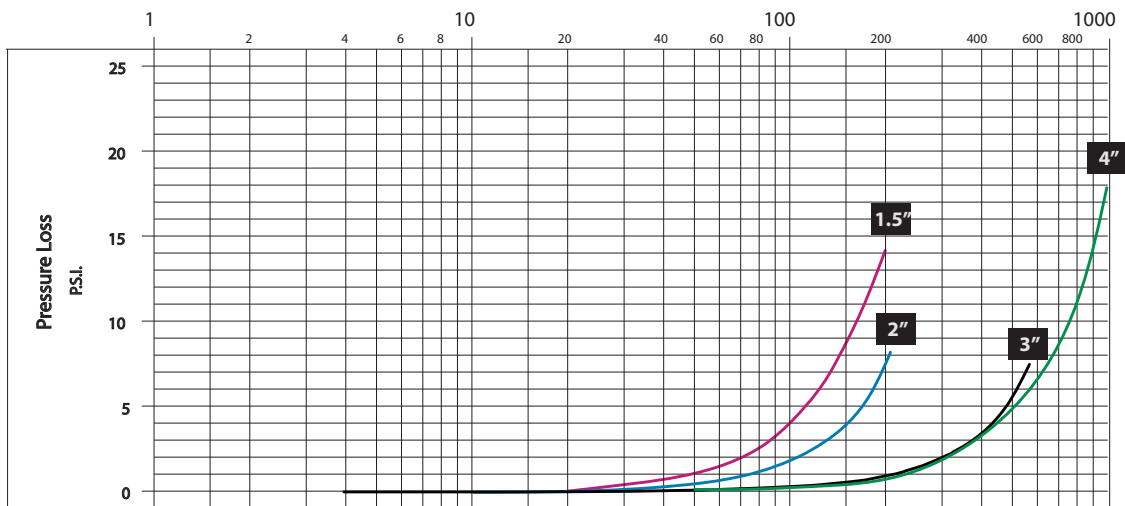

ACCURACY CHARTS FOR METERS WITHOUT STRAINER

Rate of flow in gallons per minute (gpm)

1-1/2" Meter

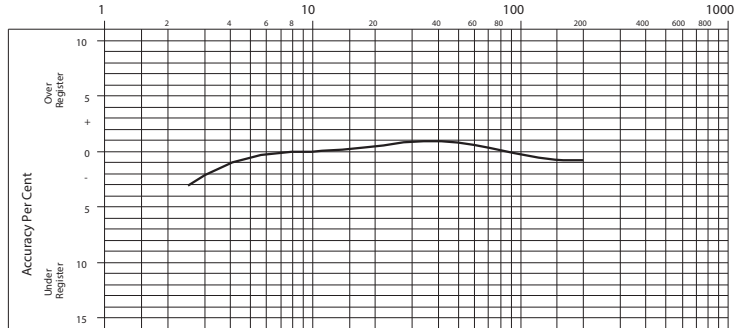

2" Meter

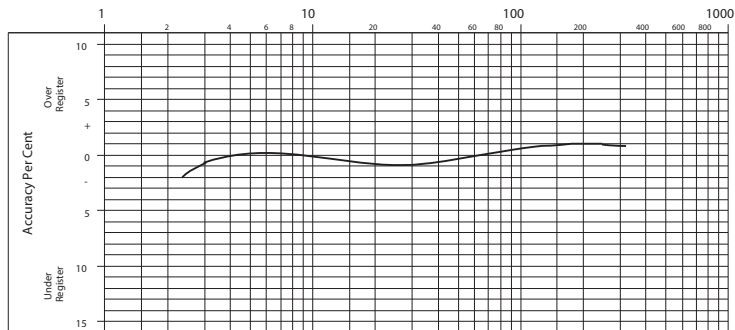

3" Meter

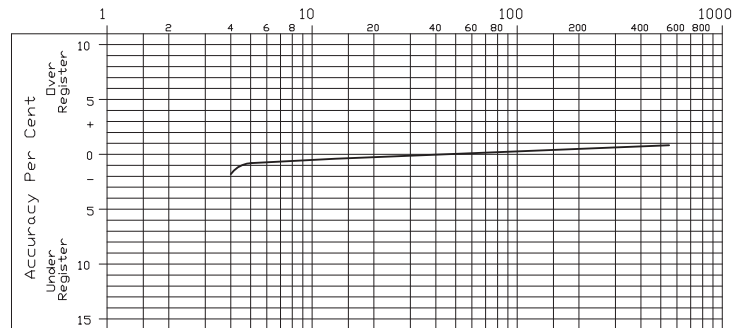

4" Meter

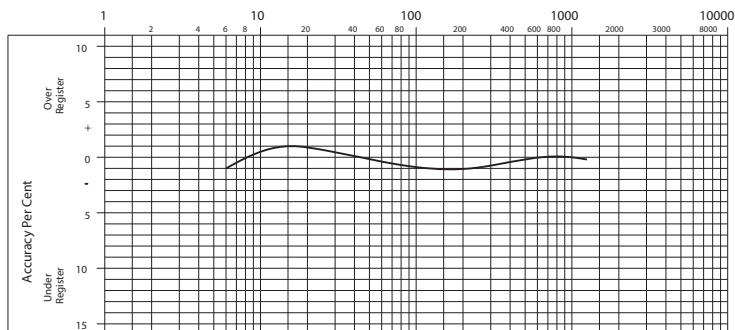

ACCURACY CHARTS FOR METERS WITHOUT STRAINER (CONTINUED)

Rate of flow in gallons per minute (gpm)

6" Meter

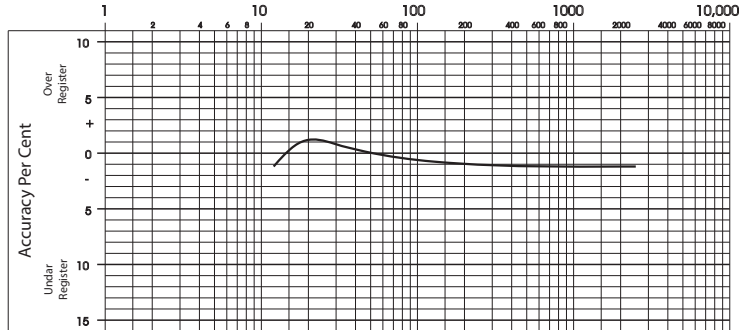

8" Meter

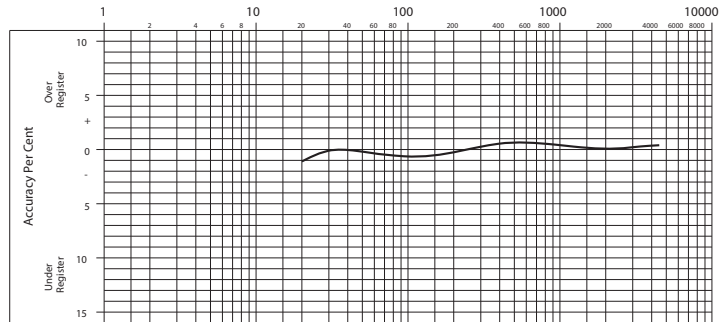

10" Meter

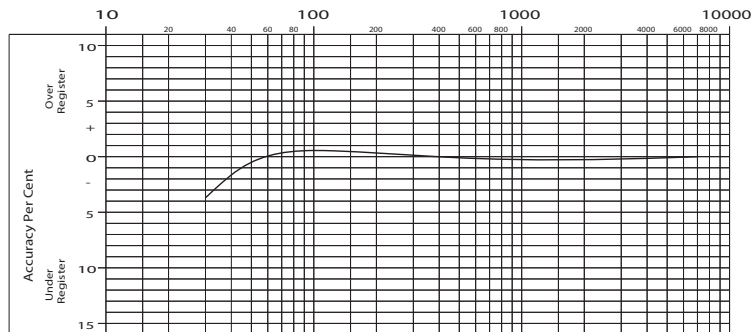

12" Meter

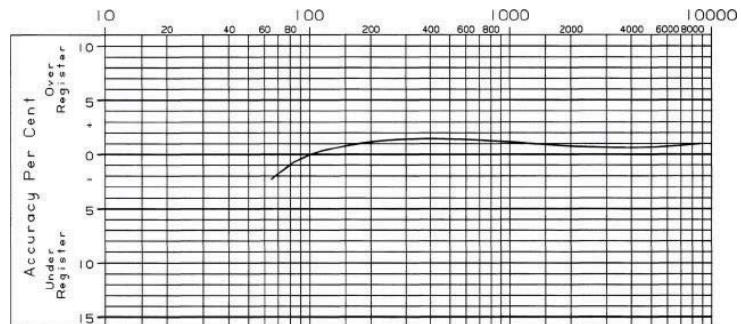

ACCURACY CHARTS FOR METERS WITH INTEGRAL STRAINER

Rate of flow in gallons per minute (gpm)

1-1/2" Meter

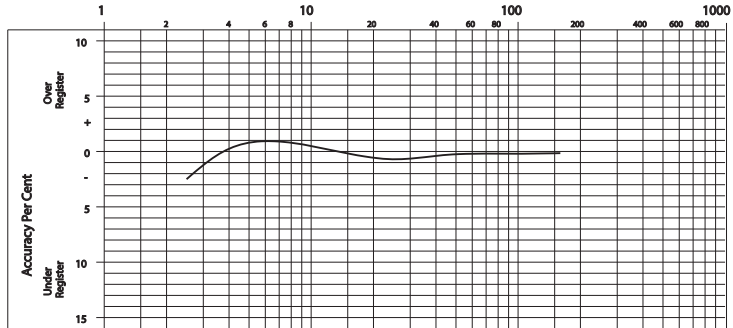

2" Meter

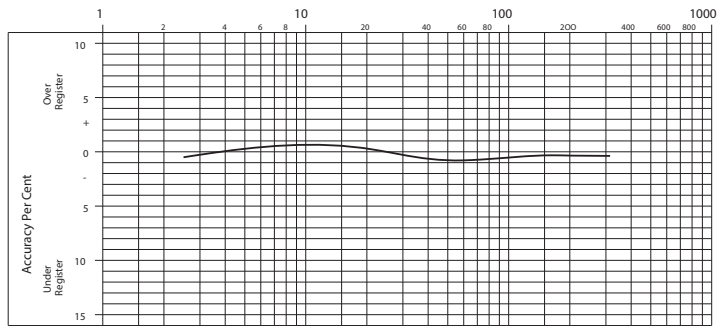

3" Meter

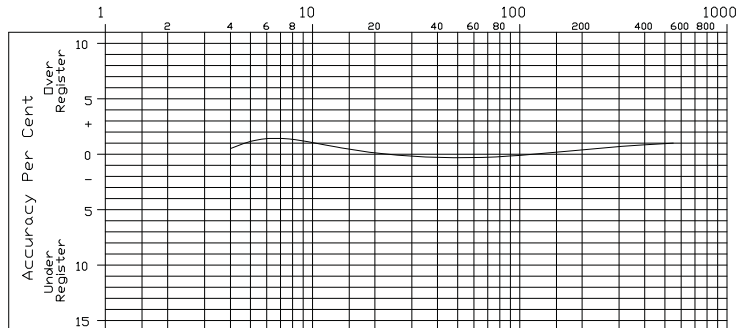

4" Meter

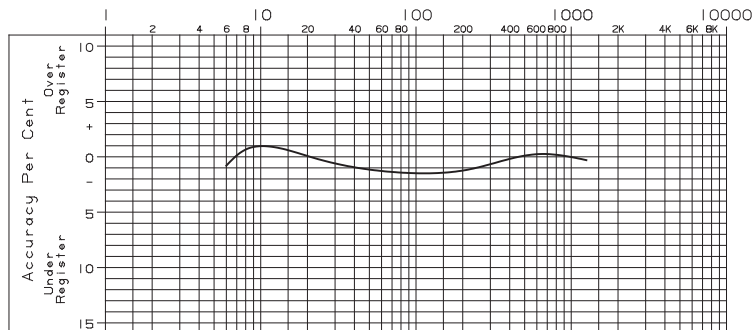

INTENTIONAL BLANK PAGE

INTENTIONAL BLANK PAGE

Making Water Visible®

MAKING WATER VISIBLE and RECORDALL are registered trademarks of Badger Meter, Inc. Other trademarks appearing in this document are the property of their respective entities. Due to continuous research, product improvements and enhancements, Badger Meter reserves the right to change product or system specifications without notice, except to the extent an outstanding contractual obligation exists. © 2014 Badger Meter, Inc. All rights reserved.

www.badgermeter.com

The Americas | Badger Meter | 4545 West Brown Deer Rd | PO Box 245036 | Milwaukee, WI 53224-9536 | 800-876-3837 | 414-355-0400

México | Badger Meter de las Americas, S.A. de C.V. | Pedro Luis Ogazón N°32 | Esq. Angelina N°24 | Colonia Guadalupe Inn | CP 01050 | México, DF | México | +52-55-5662-0882

Europe, Middle East and Africa | Badger Meter Europa GmbH | Nürtinger Str 76 | 72639 Neuffen | Germany | +49-7025-9208-0

Europe, Middle East Branch Office | Badger Meter Europe | PO Box 341442 | Dubai Silicon Oasis, Head Quarter Building, Wing C, Office #C209 | Dubai / UAE | +971-4-371 2503

Czech Republic | Badger Meter Czech Republic s.r.o. | Maříkova 2082/26 | 621 00 Brno, Czech Republic | +420-5-41420411

Slovakia | Badger Meter Slovakia s.r.o. | Raciarska 109/B | 831 02 Bratislava, Slovakia | +421-2-44 63 83 01

Asia Pacific | Badger Meter | 80 Marine Parade Rd | 21-04 Parkway Parade | Singapore 449269 | +65-63464836

China | Badger Meter | 7-1202 | 99 Hangzhong Road | Minhang District | Shanghai | China 201101 | +86-21-5763 5412

Legacy Document Numbers: RTS-T-1-1/2. 3. 4. 6. 8. 10 and 12; RTS-T-1 1-1/2, 2, 3, and 4