

Technical Datasheet

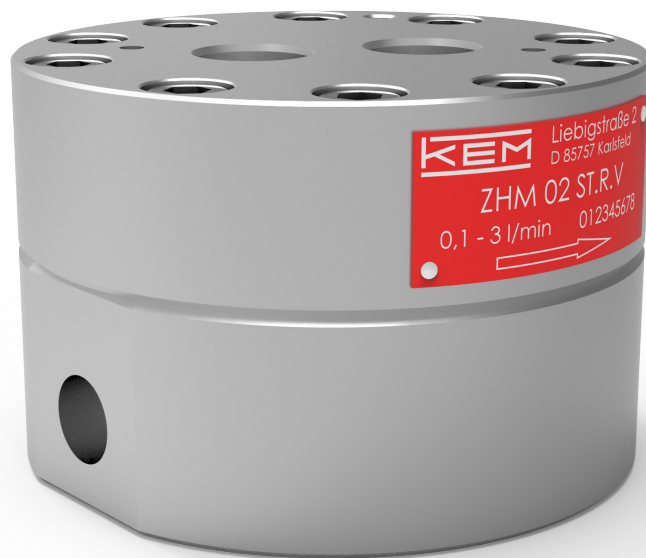

ZHM ST Series

Gear Flow Meters

for abrasive, corrosive and less lubricating fluids

Gear Flow Meters – ZHM ST Series

Overview

With more than 50 years of experience in the flow measurement field and numerous innovative and customer-specific product developments, we are a qualified and competent contact for flow measuring technology and calibration. KEM offers a broad selection of measuring principles for this purpose. We develop, produce, and deliver high quality Gear Flow Meters, Turbine Flow Meters, Helical Flow Meters and Micro Flow Meters as well as Coriolis Mass Flow Meters worldwide. Specific accessories complement the product range.

This document provides information, technical details and typical applications concerning the ZHM ST Gear Flow Meter Series.

Series	Application	Process Medium	Attributes
ZHM ST	Flow measurement	Polyol + isocyanat, glue, epoxy resins Abrasive, less lubricating Medium/high viscosity	Stainless steel body Tungsten carbide sleeve bearing Bigger tolerances
ZHM KL	Filling processes	Lubricants, oils, grease Lubricating Medium/high viscosity	Stainless steel body Stainless steel ball bearing Bigger tolerances
ZHM MK	Dosing & consumption	Diesel, Skydrol, AdBlue, odorant (Less) lubricating Low viscosity	Stainless steel body Stainless steel ball bearing Small tolerances
ZHA KL	Test bed monitoring (Hydraulics)	Hydraulic fluid, ATF Lubricating Medium viscosity	Aluminum body Stainless steel ball bearing Bigger tolerances
ZHM CT	Dosage control (Paint shops)	Paints, waxes, amine Less lubricating Medium viscosity	Stainless steel body Tungsten carbide sleeve bearing Ball bearing (optional)
ZHM HP	Flow measurement (High Pressure)	Lubricants, coolant, inhibitors Abrasive, less lubricating Medium/high viscosity	Stainless steel body Stainless steel ball bearing Tungsten carbide sleeve bearing (optional)

Please contact KEM Sales for additional information on our Flow Meters or for advisory purposes related to your individual application needs. For KEM Sales contact details see the document's last page.



Description

The ZHM ST gear flow meter series (tungsten carbide sleeve bearing design) are flow meters which are mainly used in lubrication and non-lubrication liquids. They are equally suitable for filled, viscous and abrasive media.

Only high-grade steels that even withstand corrosive liquids are used in the production of gear flow meters. Combined with the use of tungsten carbide bearings, the ZHM ST guarantees optimum measurement accuracy and a long service life under even the toughest application conditions.

The combination of various gear dimensions and modules allows a wide range of sizes that can cover a huge measuring range. This makes the ZHM ST ideal for a variety of applications in the field of metering as well as for monitoring, mixing and dosing.

Short response times, very dynamic performance and high measurement accuracy ensure accurate regulation and control of flow rates in demanding applications.

For applications in hazardous areas, we offer intrinsically safe sensors and amplifiers with Ex protection in accordance with ATEX, IECEx, CSA and other standards. Additional certifications such as EAC (TR-CU) are available.

Principle and Design

Gear flow meters (ZHM) are positive displacement meters. Two precise gears rotate freely inside the measuring chamber.

Sealed cavities are created between the gears and the housing. The measured media causes the rotation of the gears. The flowing medium is distributed evenly in the measuring chamber and causes the rotation of the gears. The gear wheels rotate freely and undamped in the media flow. Their rotational frequency is proportional to the flow rate and is measured by non-intrusive sensors (pickups) through the housing wall.

The sensor system can be variably adjusted to meet the requirements of the application. This allows, for example, providing even very high resolutions or also a signal for determining the direction of flow.

Pulses per unit of volume are available for analysis. The calibration factor (K-factor) of the flow meter describes the exact pulse rate per unit of volume. In order to determine the individual calibration factor of a flow meter, we calibrate each of our meters in house prior to delivery. The operating viscosity specified by the customer is taken into account for calibration. A corresponding calibration certificate is included with every flow meter we supply.

These meters are suitable for accurate measurement of different liquids with viscosities of approximately 1 to 25,000 mm²/s.

Thanks to a high output frequency, excellent resolution and short response times, our gear flow meters are outstanding for measuring pulsing flows, for consumption measurement and for dosing of liquids.

Applications

- Filling process
- Dosing systems
- 2-component and 3-component mixing plants
- Test stands
- Lubrication monitoring
- Consumption measurement
- Water-based paints, two component paints, highly filled metallic paints and Softfeel paints
- Preservative waxes, adhesives, PVC, epoxy resins, filled and abrasive media
- Polyol and isocyanate
- Oils, grease
- Hydraulic fluids and coolant
- Fuels, additives of any kind

Features

- High measuring accuracy up to $\pm 0.1\%$ ¹⁾
- Exceptional repeatability of $\pm 0.05\%$
- Measuring range up to 1:400
- Short response times
- Pressure-resistant up to 420 bar [6,000 psi]
- Medium temperature up to 180 °C [356 °F]
- Robust construction and long lifetime
- Applicable for electrostatic/ESTA applications

¹⁾ Under laboratory conditions; incl. linearization; viscosity ≥ 30 mm²/s.

Gear Flow Meters – ZHM ST Series

Technical Data – Sizes

ZHM Type ²⁾	Measuring Range (l/min)	K-Factor ³⁾ (pulses/l)	max. Pressure (bar/psi)	Frequency ³⁾ (Hz)	Weight (kg)
ZHM 01/1	0.005 up to 2.0	26,500	420 [6,000]	2.2 up to 880	1.3
ZHM 01/2	0,02 up to 3.0	14,000	420 [6,000]	4.6 up to 700	1.6
ZHM 02	0.1 up to 7.0	4,200	420 [6,000]	7 up to 490	2.2
ZHM 03	0.5 up to 25.0	1,740	420 [6,000]	14 up to 730	2.9
ZHM 04	0.5 up to 75.0	475	420 [6,000]	4 up to 560	8.5
ZHM 05	5,0 up to 150.0	134	250 [3,600]	11 up to 340	23.0

Technical Data – General

Measuring Accuracy	Default: $\pm 0.5\%$ Premium: $\pm 0.25\%$ ⁴⁾
Repeatability	$\pm 0.05\%$ (under the same conditions)
Materials	Housing: as per DIN 1.4305 [AISI 303], 1.4404 [AISI 316L] Gears: as per DIN 1.4122, 1.4501 [AISI F55] Bearing: Tungsten carbide sleeve bearing Seals: FKM, PTFE (others on request)
Medium Temperature	-40 °C up to +180 °C [-40 °F up to +356 °F] (others on request)
Dimensions	See dimensional drawing (page 5 to 6)



²⁾ Exact type designation see ordering code (page 7).

³⁾ Average values for single sensors, dual pickups and higher resolution available.

⁴⁾ Under laboratory conditions; incl. linearization; viscosity ≥ 30 mm²/s.

Dimensional Drawing – ZHM 01/1 to 05

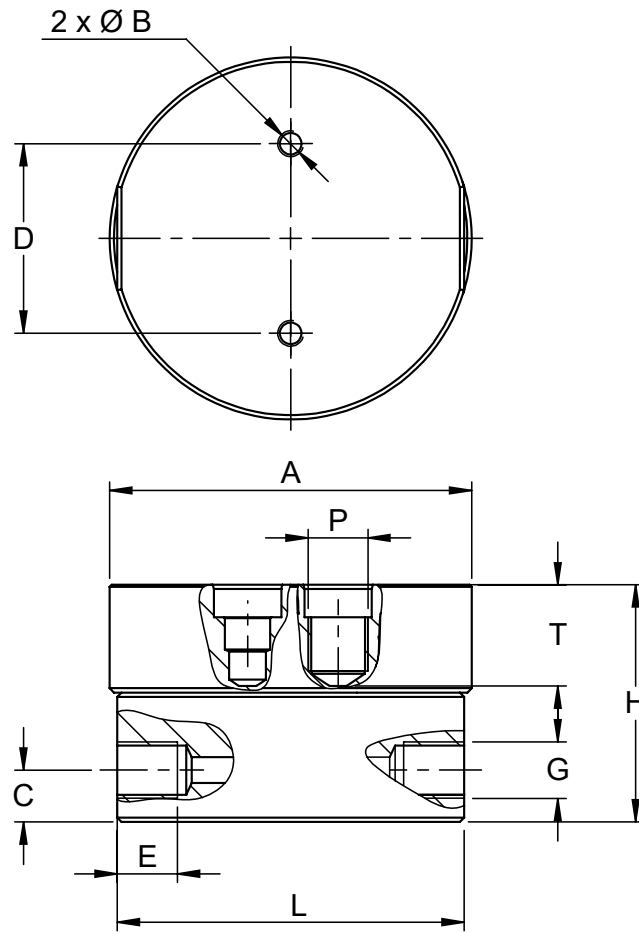

ZHM Type	Ø A	B	C	D	E	G ⁵⁾	H	L	P ⁶⁾	T ⁶⁾
ZHM 01/1	76.0 mm [2.99 in]	M6 ↓ 10	12.0 mm [0.47 in]	44.0 mm [1.73 in]	14.0 mm [0.55 in]	G ¼" ¼" NPT M12x1.5	55.0 mm [2.17 in]	72.0 mm [2.83 in]	R/B/Z	23.5 mm [0.93 in]
ZHM 01/2	76.0 mm [2.99 in]	M6 ↓ 10	12.0 mm [0.47 in]	44.0 mm [1.73 in]	14.0 mm [0.55 in]	G ¼" ¼" NPT M12x1.5	55.0 mm [2.17 in]	72.0 mm [2.83 in]	R/B/Z	23.5 mm [0.93 in]
ZHM 02	84.0 mm [3.31 in]	M6 ↓ 10	12.0 mm [0.47 in]	44.0 mm [1.73 in]	14.0 mm [0.55 in]	G ¼" ¼" NPT M12x1.5	55.0 mm [2.17 in]	80.5 mm [3.17 in]	R/B/Z	23.5 mm [0.93 in]
ZHM 03	84.0mm [3.31 in]	M6 ↓ 10	15.0 mm [0.51 in]	44.0 mm [1.73 in]	16.0 mm [0.63 in]	G ½"	67.0 mm [2.64 in]	78.0 mm [3.07 in]	R/B/Z	23.5 mm [0.93 in]
						½" NPT M12x1.5		80.5 mm [3.17 in]		
ZHM 04	125.0 mm [4.92 in]	M8 ↓ 15	19.0 mm [0.75 in]	60.0 mm [2.36 in]	17.0 mm [0.67 in]	G ¾" ¾" NPT M20x1.5	107.0 mm [4.21 in]	119.0 mm [4.69 in]	R/B/Z	30.5 mm [1.20 in]
ZHM 05	175.5 mm [6.91 in]	M8 ↓ 15	22.5 mm [0.89 in]	100.0 mm [3.94 in]	18 mm [0.71 in]	G 1" 1" NPT M33x2	133.0 mm [5.24 in]	170.0 mm [6.69 in]	H	43.5 mm [1.71 in]

⁵⁾ Others on request.

⁶⁾ Only applies for single pickup holes of type „R“.

Attention: the total installation height is the result of the height (H) and the height of the electronics (dimensions in separate datasheet).

Gear Flow Meters – ZHM ST Series

Ordering Code

	ZHM	-	XX	-	XX	-	X	-	X	-	XXX
Measuring Range											
0.005 - 2.0 l/min			01/1								
0.02 - 3.0 l/min			01/2								
0.1 - 7.0 l/min			02								
0.5 - 25.0 l/min			03								
0.5 - 75.0 l/min			04								
5.0 - 150.0 l/min ⁷⁾			05								
Meter Attributes											
Housing	Gears	Bearing	Thread								
1.4305 [AISI 303] ⁸⁾	1.4122	sleeve bearing	Metric							ST	
1.4305 [AISI 303] ⁸⁾	1.4122	sleeve bearing	BSPP							54	
1.4305 [AISI 303] ⁸⁾	1.4122	sleeve bearing	NPT							CN	
1.4404 [AISI 316L] ⁹⁾	1.4122	sleeve bearing	Metric							SO	
1.4404 [AISI 316L]	1.4122	sleeve bearing	BSPP							91	
1.4404 [AISI 316L]	1.4122	sleeve bearing	NPT							94	
1.4404 [AISI 316L]	1.4501 [AISI F55]	sleeve bearing	BSPP							J4	
1.4404 [AISI 316L]	1.4501 [AISI F55]	sleeve bearing	NPT							E7	
Sensor Ports											
M14x1,5 & Plug-in (frequency doubling, direction detection) ¹⁰⁾											R
2x M14x1,5 ¹⁰⁾											H
M14x1,5 6H ExD											Z
3/8" NPT ExD											B
Sealing Options											
FKM (Viton [®])											V
PTFE (Teflon [®])											T
FFKM (Isolast [®])											I
Bolt Options											
Standard											-
Inconel-718 (salty/harsh environment)											INC



⁷⁾ 1.4501 [AISI F55] gears not available.

⁸⁾ This option is available for ZHM 01/1 up to ZHM 04.

⁹⁾ This option is only available for ZHM 05.

¹⁰⁾ R sensor port available for ZHM 01/1 up to ZHM 04; H sensor port with ZHM 05.

Pressure Drop Curves

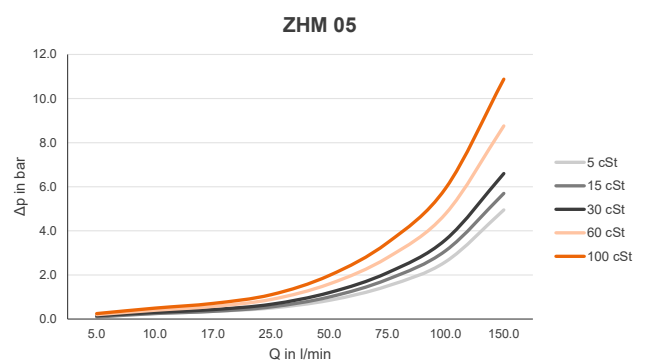
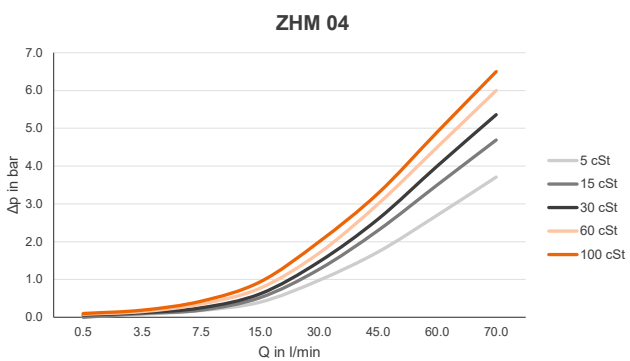
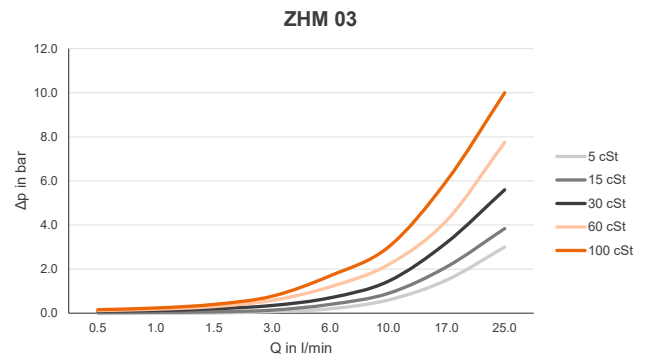
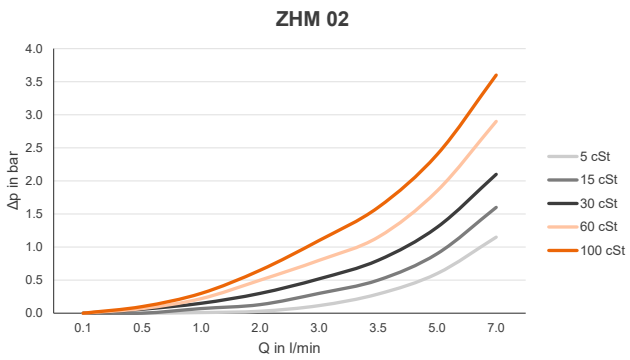
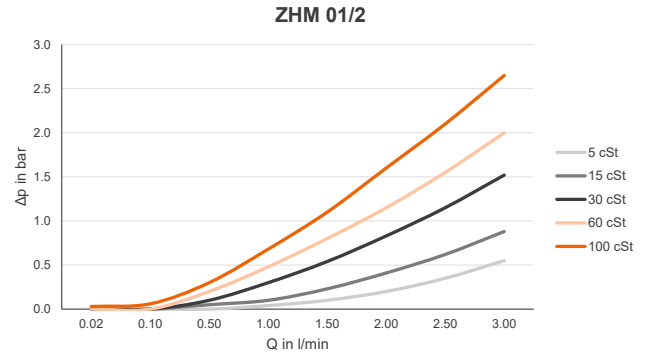
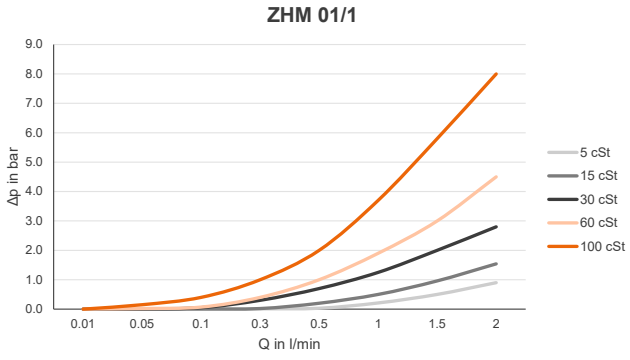

Gear Flow Meters – ZHM ST Series

Calibration

In-house calibration is performed on volumetric calibration rigs or in our DAkkS calibration laboratory, depending on the needs of the client.

The KEM calibration lab uses a high-precision load cell system. With an accuracy of 0.05 % for the mass and 0.1 % for the volume of flowing liquids, we occupy a leading position worldwide. The German Accreditation Body (DAkkS) has accredited the laboratory engineers, processes and measuring equipment in accordance with the international standard DIN EN ISO/IEC 17025:2018.

The KEM calibration certificate not only verifies the accuracy of a flow meter, but also guarantees its traceability to national standards ensuring all requirements according to international quality standards are met.

The calibrations are performed with different hydrocarbons. This ensures the optimum simulation of changing operating conditions in density and viscosity even when temperatures change. This way the primary viscosity for the use of the flow meter can be specifically taken into account when viscosity fluctuations occur in a customised application.

The calibration result is the specified calibration factor (K-factor) in pulses per litre. This K-factor accordingly applies only at a certain flow velocity or a certain flow rate.

The calibration factor varies only very slightly at different volume flow rates. The individual measuring points provide the calibration curve of the flow meter from which the average K-factor is determined. The average calibration factor applies to the entire measuring range.

The linearity specification (percent deviation) refers to the average K-factor. To further increase the measurement accuracy in onsite use, the specific K-factors can be used to calculate the flow rate. For this, KEM also supplies optional special electronics.

Calculation of volume flow

The flow is directly dependent on the measured frequency and the associated calibration factor:

$$Q = \frac{f \cdot 60}{K} \text{ l/min}$$

- Q = Volume Flow
- f = Measuring frequency
- K = Specific K-Factor

Calibration protocol

Example: ZHM 02 ST (0.1 to 7 l/min)

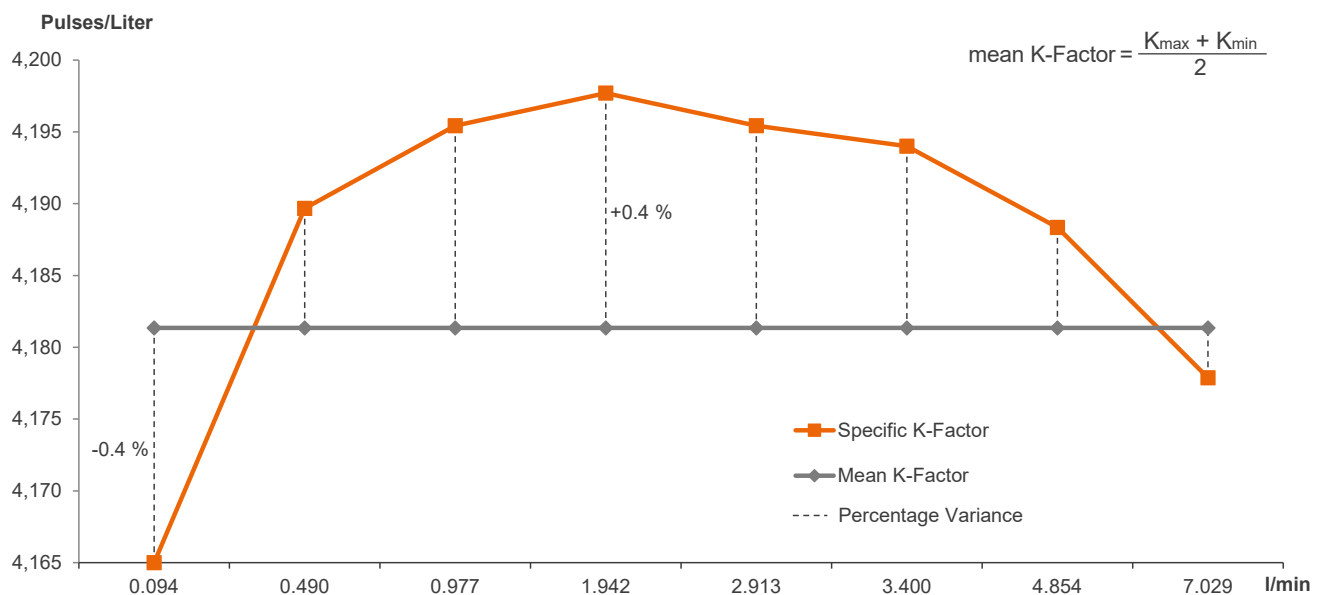



KEM Headquarters

Liebigstraße 5
85757 Karlsfeld
Germany

T. +49 8131 59391-0
F. +49 8131 92604

info@kem-kueppers.com

KEM Manufacturing Center

Wetzeller Straße 22
93444 Bad Kötzing
Germany

T. +49 9941 9423-0
F. +49 9941 9423-23

production@kem-kueppers.com

KEM Sales

Liebigstraße 5
85757 Karlsfeld
Germany

T. +49 8131 59391-100
F. +49 8131 92604

sales@kem-kueppers.com

KEM Service & Repairs

Wetzeller Straße 22
93444 Bad Kötzing
Germany

T. +49 9941 9423-37
F. +49 9941 9423-24

service@kem-kueppers.com

*More distributors & partners can be found at:
www.kem-kueppers.com*