

### Portable Ultrasonic Flow Measurement of Gas

Portable instrument for non-intrusive, quick ultrasonic flow measurement with clamp-on technology for all types of piping

#### Features

- Precise bi-directional and highly dynamic flow measurement with the non-intrusive clamp-on technology
- High precision at fast and slow flow rates, high temperature and zero point stability
- Portable, easy-to-use flow transmitter with 2 flow channels, multiple inputs/outputs, an integrated data logger with a serial interface
- Water and dust-tight (IP65); resistant against oil, many liquids and dirt
- Li-Ion battery provides up to 14 hours of measurement operation
- Automatic loading of calibration data and transducer detection for a fast and easy set-up (less than 5 min), providing precise and long-term stable results
- User-friendly design
- Transducers available for a wide range of inner pipe diameters (6...2100 mm) and fluid temperatures (-40...+200 °C)
- Probe for wall thickness measurement available
- Robust, water-tight (IP67) transport case with comprehensive accessories
- QuickFix for fast mounting of the flow transmitter in difficult conditions

#### Applications

Designed for industrial use in harsh environments, in gas processing and natural gas extraction, chemical industry and in the petroleum industry. Practical applications:

- Measurement on natural gas pipelines and in natural gas storage installations
- Measurement of synthesized gas and injection gas
- Measurement for the gas supply industry
- Supervision of permanently installed meters, service and maintenance



FLUXUS G601 supported by handle

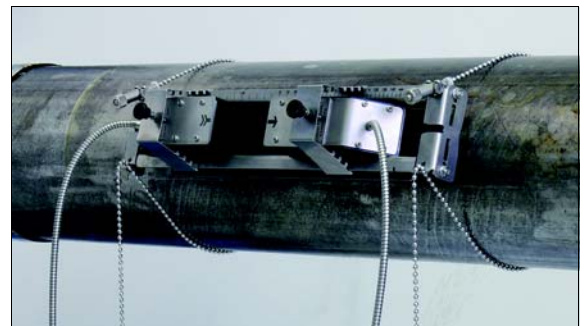

Measurement with transducers mounted by the portable Variofix VP



Measurement equipment in transport case

## Table of Contents

<b>Function</b> .....	3
Measurement Principle .....	3
Calculation of Volumetric Flow Rate .....	3
Number of Sound Paths .....	4
Typical Measurement Setup .....	5
Standard Volumetric Flow Rate .....	5
<b>Flow Transmitter</b> .....	6
Technical Data .....	6
Dimensions .....	8
Standard Scope of Supply .....	9
Connection of Adapters.....	10
Example for the Equipment of a Transport Case .....	11
<b>Transducers</b> .....	12
Transducer Selection .....	12
Transducer Order Code .....	15
Technical Data .....	16
<b>Transducer Mounting Fixture</b> .....	21
<b>Coupling Materials for Transducers</b> .....	23
<b>Damping Mats (optional)</b> .....	24
<b>Connection Systems</b> .....	25
Transducer Cable.....	25
<b>Clamp-on Temperature Probe (optional)</b> .....	26
<b>Wall Thickness Measurement (optional)</b> .....	27

## Function

### Measurement Principle

In order to measure the flow of a medium in a pipe, ultrasonic signals are used, employing the transit time difference principle. Ultrasonic signals are emitted by a transducer installed on the pipe and received by a second transducer. These signals are emitted alternately in the flow direction and against it.

As the medium in which the signals propagate is flowing, the transit time of the ultrasonic signals in the flow direction is shorter than against the flow direction.

The transit time difference,  $\Delta t$ , is measured and allows the flowmeter to determine the average flow velocity along the propagation path of the ultrasonic signals. A flow profile correction is then performed in order to obtain the area averaged flow velocity, which is proportional to the volumetric flow rate.

Two integrated microprocessors control the entire measuring process. This allows the flowmeter to remove disturbance signals, and to check each received ultrasonic wave for its validity which reduces noise.

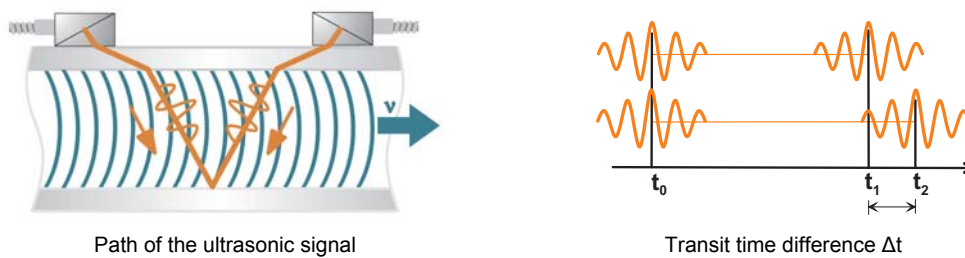

### Calculation of Volumetric Flow Rate

$$\dot{V} = k_{Re} \cdot A \cdot k_a \cdot \Delta t / (2 \cdot t_{fl})$$

where

- $\dot{V}$  - volumetric flow rate
- $k_{Re}$  - fluid mechanics calibration factor
- $A$  - cross-sectional pipe area
- $k_a$  - acoustical calibration factor
- $\Delta t$  - transit time difference
- $t_{fl}$  - transit time in the medium

### Number of Sound Paths

The number of sound paths is the number of transits of the ultrasonic signal through the medium in the pipe. Depending on the number of sound paths, the following methods of installation exist:

- **reflection arrangement**

The number of sound paths is even. Both of the transducers are mounted on the same side of the pipe. Correct positioning of the transducers is easier.

- **diagonal arrangement**

The number of sound paths is odd. Both of the transducers are mounted on opposite sides of the pipe. In the case of a high signal attenuation by the medium, pipe and coatings, diagonal arrangement with 1 sound path will be used.

The preferred method of installation depends on the application. While increasing the number of sound paths increases the accuracy of the measurement, signal attenuation increases as well. The optimum number of sound paths for the parameters of the application will be determined automatically by the transmitter.

As the transducers can be mounted with the transducer mounting fixture in reflection arrangement or diagonal arrangement, the number of sound paths can be adjusted optimally for the application.

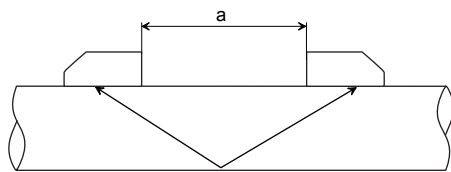

a - transducer distance

Reflection arrangement, number of sound paths: 2

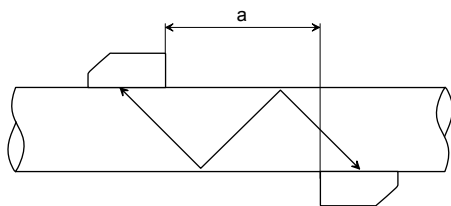

Diagonal arrangement, number of sound paths: 3

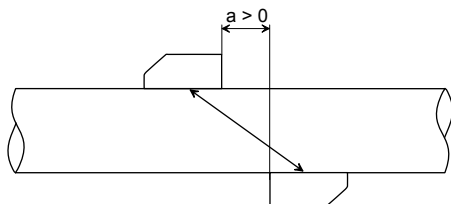

Diagonal arrangement, number of sound paths: 1

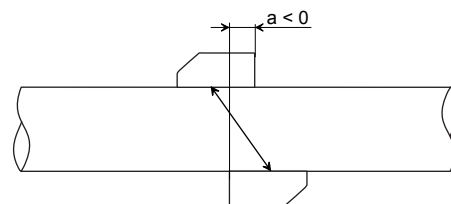

Diagonal arrangement, number of sound paths: 1, negative transducer distance

### Typical Measurement Setup

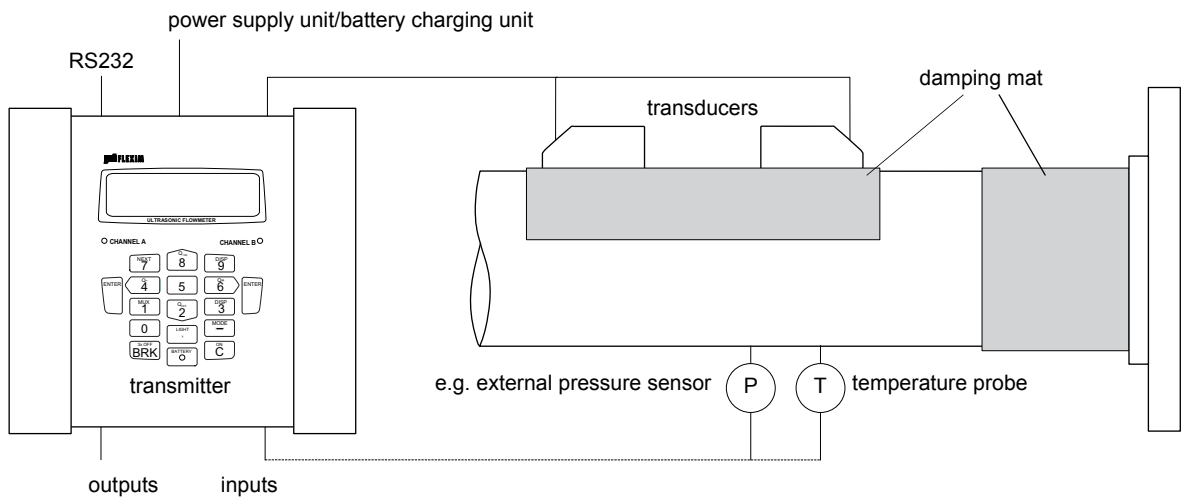

Example of a measurement setup in reflection arrangement with connection of the inputs to an external process pressure and process temperature measurement for standard volumetric flow rate calculation

### Standard Volumetric Flow Rate

The standard volumetric flow rate can be selected as physical quantity to be measured. It will be calculated internally by:

$$\dot{V}_N = \dot{V} \cdot p/p_N \cdot T_N/T \cdot 1/K$$

where

- $\dot{V}_N$  - standard volumetric flow rate
- $\dot{V}$  - operating volumetric flow rate
- $p_N$  - standard pressure (absolute value)
- $p$  - operating pressure (absolute value)
- $T_N$  - standard temperature in K
- $T$  - operating temperature in K
- $K$  - compressibility coefficient of the gas: ratio of the compressibility factors of the gas at operating conditions and at standard conditions  $Z/Z_N$

The operational pressure  $p$  and the operational temperature  $T$  of the medium will be entered directly as fixed values into the transmitter.

or:

If inputs are installed (optional), pressure and temperature can be measured by the customer and fed in the transmitter.

The gas compressibility coefficient  $K$  of the gas is entered in the transmitter:

- as fixed value or
- as approximation according to e.g. AGA8 or GERG

## Flow Transmitter

### Technical Data

FLUXUS	G601
design	portable
	
<b>measurement</b>	
measurement principle	transit time difference correlation principle
flow velocity	0.01...35 m/s, depending on pipe diameter
repeatability	0.15 % of reading $\pm 0.01$ m/s
medium	all acoustically conductive gases, e.g. nitrogen, air, oxygen, hydrogen, argon, helium, ethylene, propane
temperature compensation	corresponding to the recommendations in ANSI/ASME MFC-5.1-2011
<b>accuracy</b>	
volumetric flow rate	$\pm 1...3$ % of reading $\pm 0.01$ m/s depending on application $\pm 0.5$ % of reading $\pm 0.01$ m/s with field calibration
<b>flow transmitter</b>	
power supply	100...240 V/50...60 Hz (power supply unit), 10.5...15 V DC (socket at transmitter), integrated battery
battery	Li-Ion, 7.2 V/4.5 Ah operating time (without outputs, inputs and backlight): > 14 h
power consumption	< 6 W
number of flow measuring channels	2
damping	0...100 s, adjustable
measuring cycle (1 channel)	100...1000 Hz
response time	1 s (1 channel), option: 70 ms
housing material	PA, TPE, AutoTex, stainless steel
degree of protection according to IEC/EN 60529	IP65
dimensions	see dimensional drawing
weight	1.9 kg
fixation	QuickFix pipe mounting fixture
ambient temperature	-10...+60 °C
display	2 x 16 characters, dot matrix, backlight
menu language	English, German, French, Dutch, Spanish
<b>measuring functions</b>	
physical quantities	operating volumetric flow rate, standard volumetric flow rate, mass flow rate, flow velocity
totalizer	volume, mass
calculation functions	average, difference, sum
diagnostic functions	sound speed, signal amplitude, SNR, SCNR, standard deviation of amplitudes and transit times
<b>data logger</b>	
loggable values	all physical quantities, totalized values and diagnostic values
capacity	> 100 000 measured values

FLUXUS	G601
<b>communication</b>	
interface	RS232/USB
<b>serial data kit</b>	
software (all Windows™ versions)	<ul style="list-style-type: none"> <li>- FluxData: download of measurement data, graphical presentation, conversion to other formats (e.g. for Excel™)</li> <li>- FluxDiag (optional): online diagnostics and report generation</li> <li>- FluxKoef: creating medium data sets</li> <li>- FluxSubstanceLoader: upload of medium data sets</li> </ul>
cable	RS232
adapter	RS232 - USB
<b>transport case</b>	
dimensions	500 x 400 x 190 mm
<b>outputs</b>	
	The outputs are galvanically isolated from the transmitter.
number	see standard scope of supply on page 9, max. on request
accessories	output adapter (if number of outputs > 4)
<b>current output</b>	
range	0/4...20 mA
accuracy	0.1 % of reading ±15 µA
active output	$R_{ext} < 200 \Omega$
passive output	$U_{ext} = 4...16 \text{ V}$ , depending on $R_{ext}$ $R_{ext} < 500 \Omega$
<b>frequency output</b>	
range	0...5 kHz
open collector	24 V/4 mA
<b>binary output</b>	
optorelay	26 V/100 mA
binary output as alarm output - functions	limit, change of flow direction or error
binary output as pulse output - pulse value - pulse width	0.01...1000 units 1...1000 ms
<b>inputs</b>	
	The inputs are galvanically isolated from the transmitter.
number	see standard scope of supply on page 9, max. 4
accessories	input adapter (if number of inputs > 2)
<b>temperature input</b>	
type	Pt100/Pt1000
connection	4-wire
range	-150...+560 °C
resolution	0.01 K
accuracy	±0.01 % of reading ±0.03 K
<b>current input</b>	
accuracy	0.1 % of reading ±10 µA
passive input	$R_{int} = 50 \Omega$ , $P_{int} < 0.3 \text{ W}$
- range	-20...+20 mA
<b>voltage input</b>	
range	0...1 V
accuracy	0.1 % of reading ±1 mV
internal resistance	$R_{int} = 1 \text{ M}\Omega$

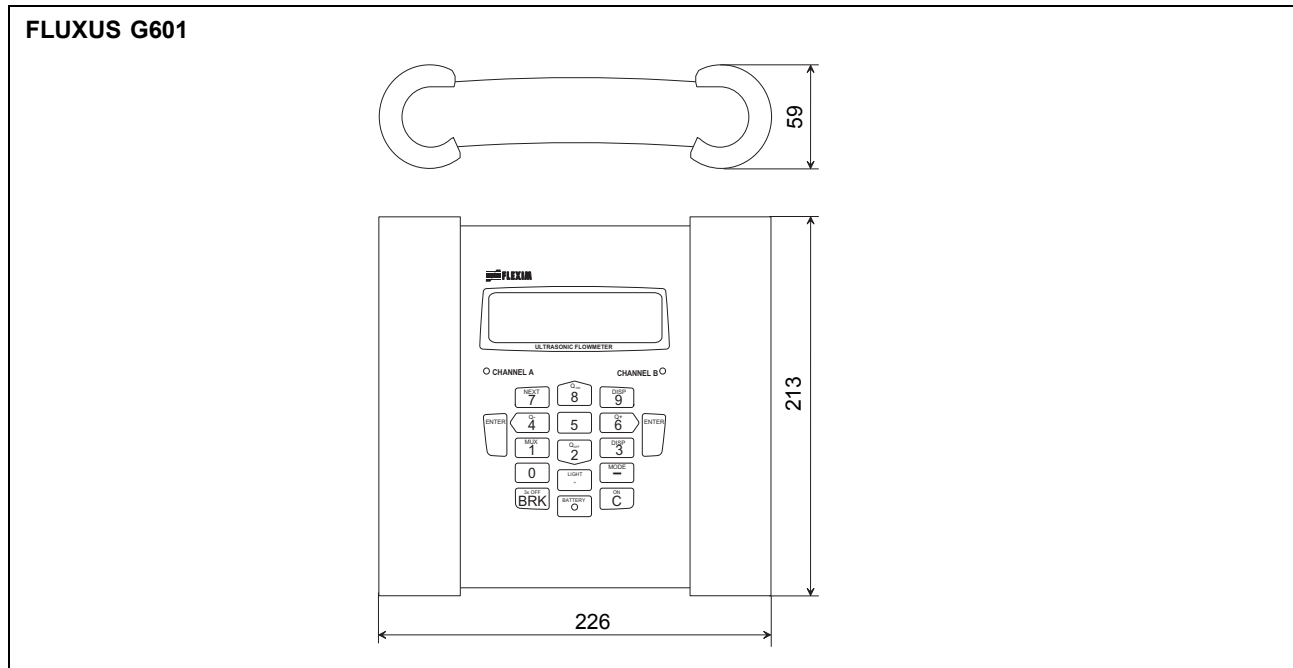

### Dimensions



in mm

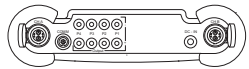
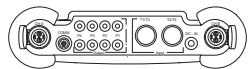
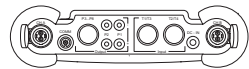

### Standard Scope of Supply

	G601 Standard	G601 Extended Standard	G601 Multifunctional	G601 CA-Energy
application	flow measurement on gas			flow measurement on compressed air, industrial gases and liquids
	2 independent measuring channels			
	calculation of standard volumetric flow rate	calculation of standard volumetric flow rate, with optional use of current measured pressure and temperature values		
		simultaneous monitoring of flow and energy flow	simultaneous monitoring of 2 energy flows	liquids: integrated heat flow computer for monitoring of energy flows
<b>outputs</b>				
passive current output	2	2	2	2
binary output	2	1	2	2
frequency output	-	1	1	-
<b>inputs</b>				
temperature input	-	-	1	2
passive current input	-	2	2	2
voltage input	-	-	1	-
<b>accessories</b>				
transport case	x	x	x	x
power supply unit, mains cable	x	x	x	x
battery	x	x	x	x
output adapter	-	-	x	-
input adapter	-	2	2	2
adapter for voltage and current inputs	-	-	3	2
QuickFix pipe mounting fixture for transmitter	x	x	x	x
serial data kit	x	x	x	x
measuring tape	x	x	x	x
wall thickness probe	-	-	x	x
user manual, Quick Start Guide	x	x	x	x
connector board at the upper side of the transmitter				

### Connection of Adapters

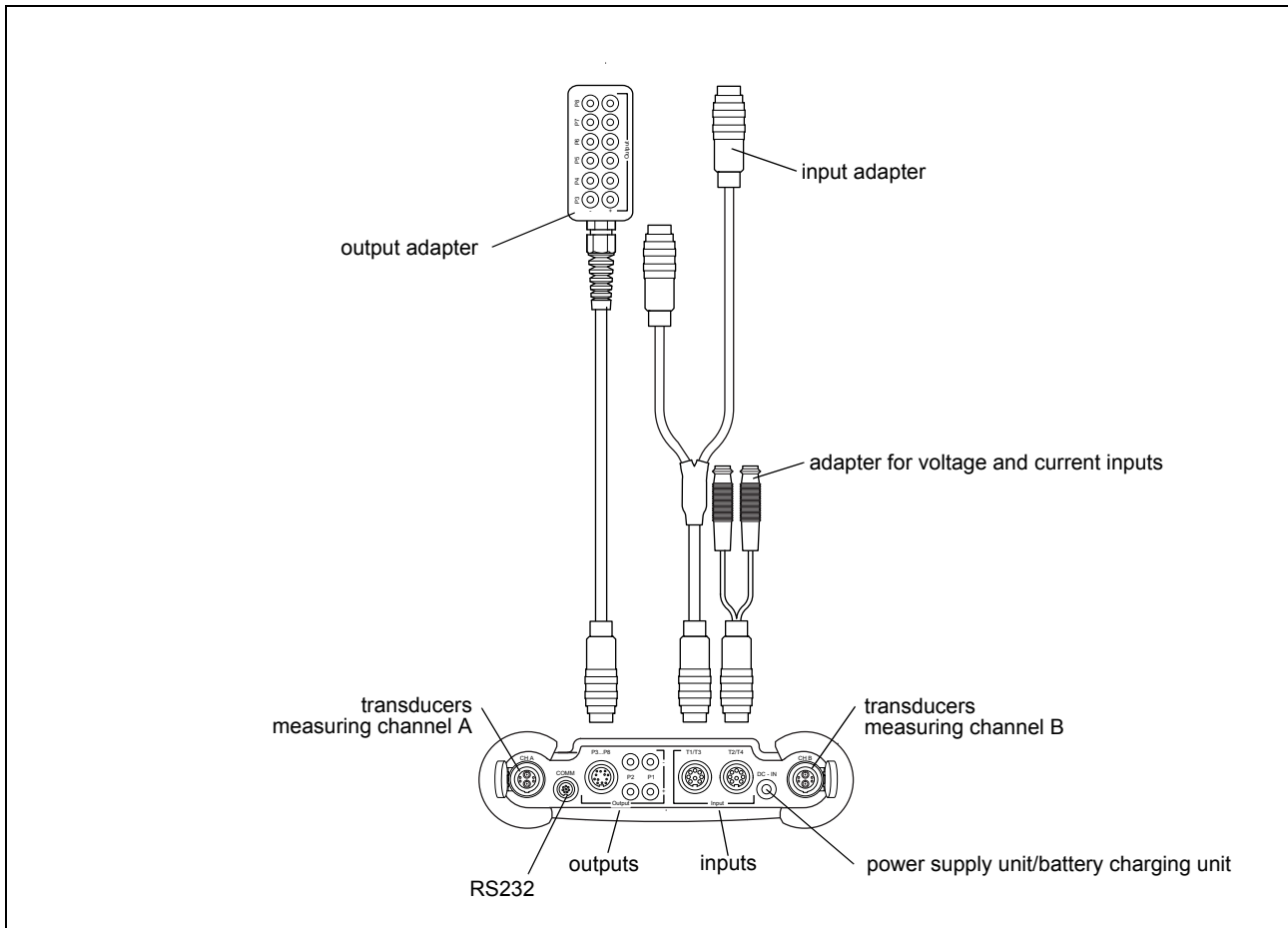

### Example for the Equipment of a Transport Case



## Transducers

### Transducer Selection

#### Step 1a

Select a Lamb wave transducer:

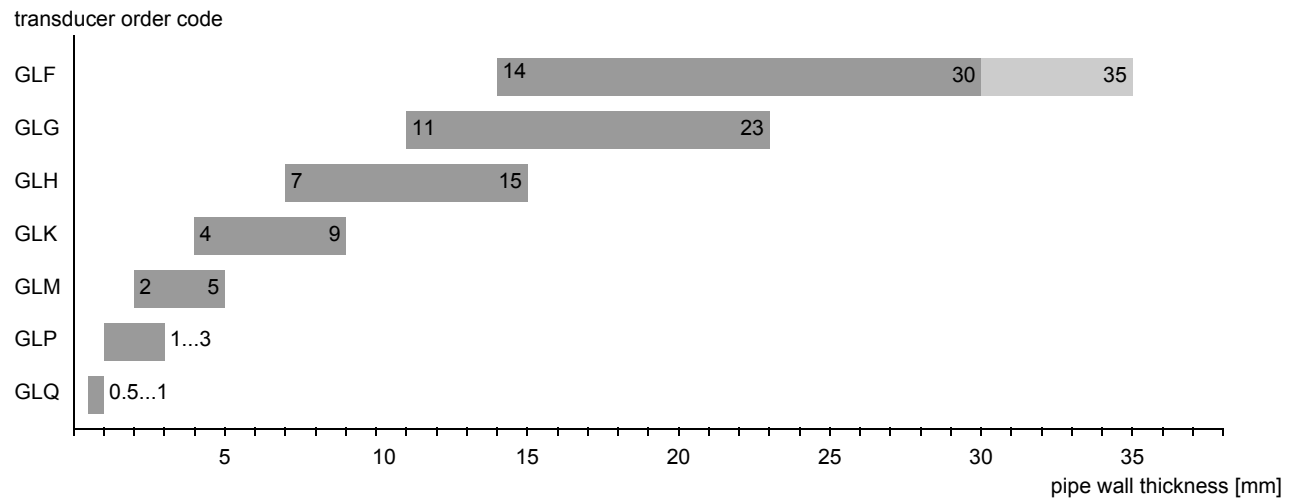

#### Step 1b

If the pipe wall thickness is not in the range of the Lamb wave transducers, select a shear wave transducer:

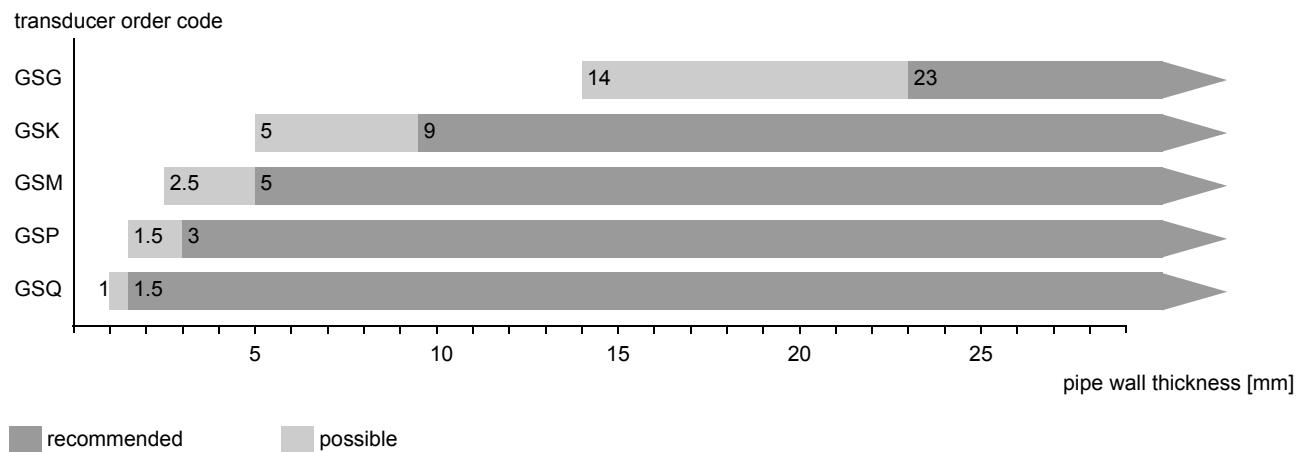

■ recommended      ■ possible

#### Step 2

inner pipe diameter  $d$  dependent on the flow velocity  $v$  of the medium in the pipe

The transducers are selected from the characteristics (see next page). Lamb wave transducers are selected from the left column, shear wave transducers from the right column.

Lamb wave transducers: If the values  $d$  and  $v$  are not in the range, the diagonal arrangement with 1 sound path may be used, i.e. the same characteristics can be used with doubling the inner pipe diameter. If the values are still not in the range, shear waves transducers regarding the pipe wall thickness have to be selected in step 1b.

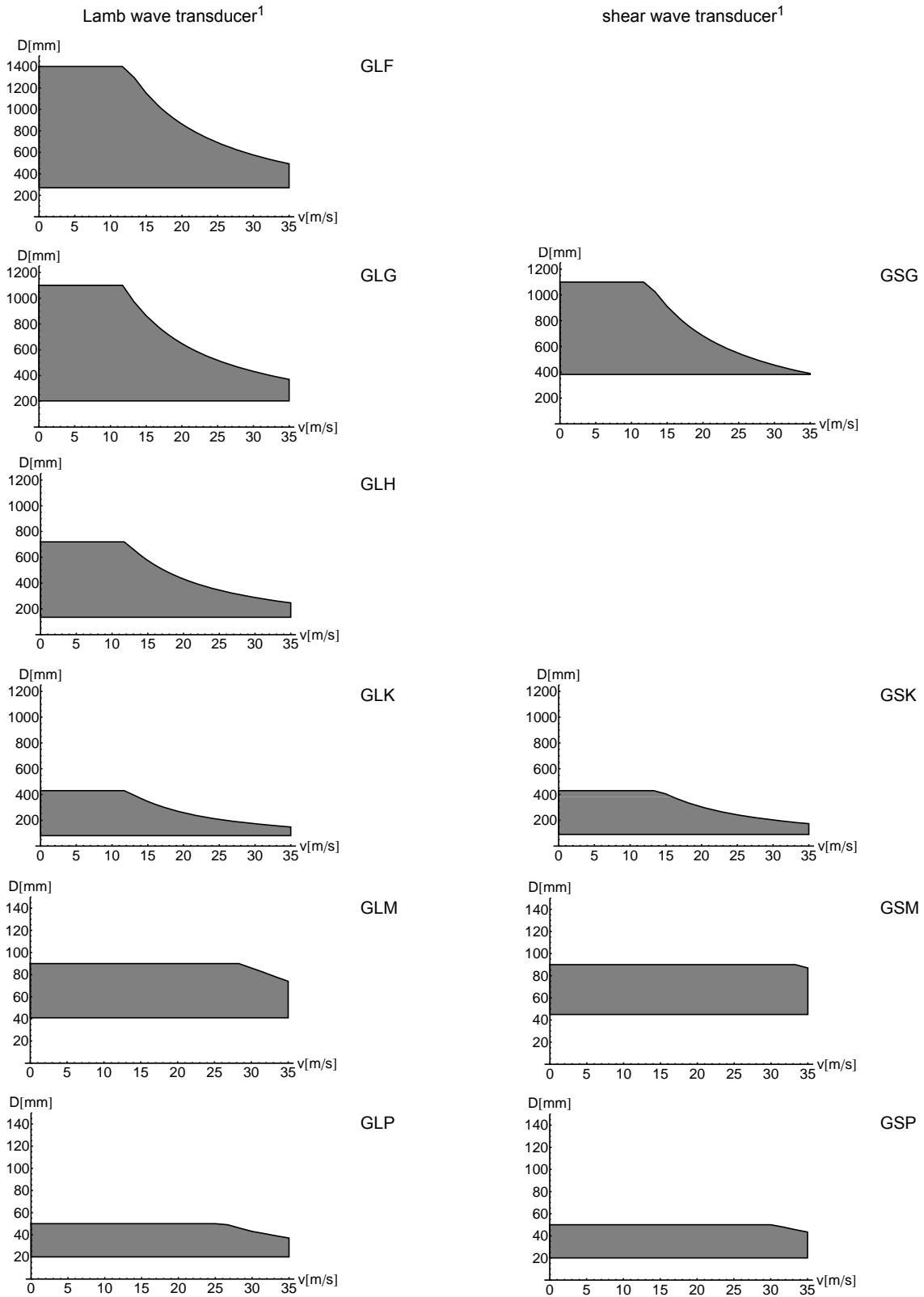

<sup>1</sup> inner pipe diameter and max. flow velocity for a typical application with natural gas, nitrogen, oxygen in reflection arrangement with 2 sound paths (Lamb wave transducers)/1 sound path (shear wave transducers)

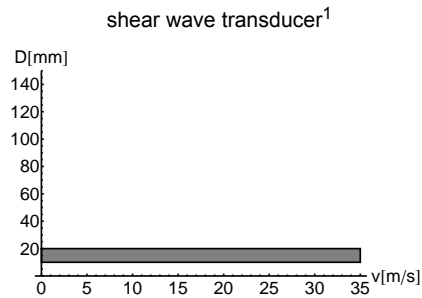
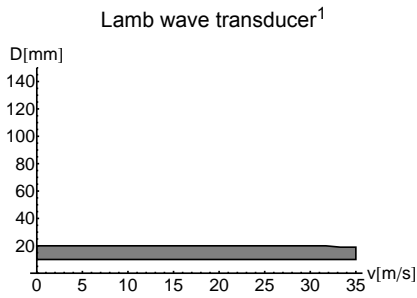

<sup>1</sup> inner pipe diameter and max. flow velocity for a typical application with natural gas, nitrogen, oxygen in reflection arrangement with 2 sound paths (Lamb wave transducers)/1 sound path (shear wave transducers)

**Step 3**

min. medium pressure

Lamb wave transducer			
transducer order code	medium pressure <sup>1</sup> [bar]		
	metal pipe		plastic pipe
	min.	min. extended	min.
GLF	15	10	1
GLG	15	10	1
GLH	15	10	1
GLK	15 (d > 120 mm) 10 (d < 120 mm)	10 (d > 120 mm) 3 (d < 120 mm)	1
GLM	10 (d > 60 mm) 5 (d < 60 mm)	3 (d < 60 mm)	1
GLP	10 (d > 35 mm) 5 (d < 35 mm)	3 (d < 35 mm)	1
GLQ	10 (d > 15 mm) 5 (d < 15 mm)	3 (d < 15 mm)	1

shear wave transducer			
transducer order code	medium pressure <sup>1</sup> [bar]		
	metal pipe		plastic pipe
	min.	min. extended	min.
GSG	30	20	1
GSK	30	20	1
GSM	30	20	1
GSP	30	20	1
GSQ	30	20	1

<sup>1</sup> depending on application, typical absolute value for natural gas, nitrogen, compressed air

d - inner pipe diameter

**Example**

step						
1	pipe wall thickness selected transducer	mm	12 GLG or GLH	12 GLG or GLH	12 GLG or GLH	30 GS
2	inner pipe diameter max. flow velocity selected transducer	mm m/s	800 15 GLG	600 15 GLG or GLH	800 30 values not in the range of the characteristics, but by using diagonal arrangement with 1 sound path, the inner pipe diameter in the characteristics is doubled: GLG	300 15 GSK
3	min. medium pressure selected transducer	bar	17 GLG	17 GLG or GLH influence of acoustic noise is reduced with increased transducer frequency, thus recommended: GLH	17 GLG	35 GSK

**Step 4**

for the characters 4...11 of the transducer order code (ambient temperature, explosion protection, connection system, extension cable) see page 15

**Step 5**

for the technical data of the selected transducer see page 16 et seqq.

### Transducer Order Code

1, 2	3	4	5, 6	7, 8	9...11	no. of character		
transducer	transducer frequency	-	ambient temperature	explosion protection	connection system	-	extension cable	description
GL								set of ultrasonic flow transducers for gas measurement, Lamb wave
GS								set of ultrasonic flow transducers for gas measurement, shear wave
	F							0.15 MHz (Lamb wave only)
	G							0.2 MHz
	H							0.3 MHz (Lamb wave only)
	K							0.5 MHz
	M							1 MHz
	P							2 MHz
	Q							4 MHz
		N						normal temperature range
		E						extended temperature range (shear wave transducers with transducer frequency M, P, Q)
			NN					not explosion proof
				NL				with Lemo connector
						XXX		cable length in m, for max. length of extension cable see page 25
example								
GL	K	-	N	NN	NL	-	000	Lamb wave transducer 0.5 MHz, normal temperature range, connection system NL with Lemo connector
		-				-		

## Technical Data

### Shear Wave Transducers

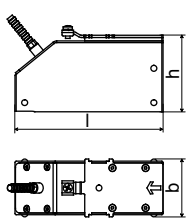
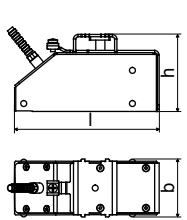
technical type		GDG1NZ7	GDK1NZ7
order code		<b>GSG-NNNNL</b>	<b>GSK-NNNNL</b>
transducer frequency	MHz	0.2	0.5
<b>medium pressure<sup>1</sup></b>			
min. extended	bar	metal pipe: 20	metal pipe: 20
min.	bar	metal pipe: 30 plastic pipe: 1	metal pipe: 30 plastic pipe: 1
<b>inner pipe diameter d<sup>2</sup></b>			
min. extended	mm	250	70
min. recommended	mm	380	80
max. recommended	mm	810	500
max. extended	mm	1100	720
<b>pipe wall thickness</b>			
min.	mm	14	5
max.	mm	-	-
<b>material</b>			
housing		PEEK with stainless steel cap 304 (1.4301)	PEEK with stainless steel cap 304 (1.4301)
contact surface		PEEK	PEEK
degree of protection according to IEC/EN 60529		IP67	IP67
<b>transducer cable</b>			
type		1699	1699
length	m	5	5
<b>dimensions</b>			
length l	mm	129.5	126.5
width b	mm	51	51
height h	mm	67	67.5
dimensional drawing			
<b>ambient temperature</b>			
min.	°C	-40	-40
max.	°C	+130	+130
temperature compensation		x	x

<sup>1</sup> depending on application, typical absolute value for natural gas, nitrogen, compressed air

<sup>2</sup> shear wave transducer:

typical values for natural gas, nitrogen, oxygen, pipe diameters for other gases on request

pipe diameter min. recommended/max. recommended/max. extended: in diagonal arrangement and for a flow velocity of 15 m/s

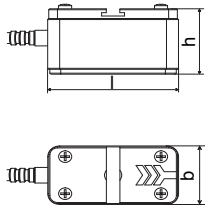
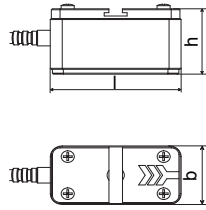
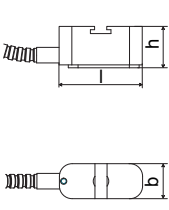

technical type		GDM1NZ7	GDP1NZ7	GDQ1NZ7
order code		<b>GSM-NNNNL</b>	<b>GSP-NNNNL</b>	<b>GSQ-NNNNL</b>
transducer frequency	MHz	1	2	4
<b>medium pressure<sup>1</sup></b>				
min. extended min.	bar bar	metal pipe: 20 metal pipe: 30 plastic pipe: 1	metal pipe: 20 metal pipe: 30 plastic pipe: 1	metal pipe: 20 metal pipe: 30 plastic pipe: 1
<b>inner pipe diameter d<sup>2</sup></b>				
min. extended	mm	30	15	6
min. recommended	mm	40	20	10
max. recommended	mm	80	40	20
max. extended	mm	120	60	30
<b>pipe wall thickness</b>				
min.	mm	2.5	1.5	1
max.	mm	-	-	-
<b>material</b>				
housing		stainless steel 304 (1.4301)	stainless steel 304 (1.4301)	stainless steel 304 (1.4301)
contact surface		PEEK	PEEK	PEEK
degree of protection according to IEC/ EN 60529		IP67	IP67	IP67
<b>transducer cable</b>				
type		1699	1699	1699
length	m	4	4	3
<b>dimensions</b>				
length l	mm	60	60	42.5
width b	mm	30	30	18
height h	mm	33.5	33.5	21.5
dimensional drawing				
<b>ambient temperature</b>				
min.	°C	-40	-40	-40
max.	°C	+130	+130	+130
temperature compensation		x	x	x

<sup>1</sup> depending on application, typical absolute value for natural gas, nitrogen, compressed air

<sup>2</sup> shear wave transducer:

typical values for natural gas, nitrogen, oxygen, pipe diameters for other gases on request

pipe diameter min. recommended/max. recommended/max. extended: in diagonal arrangement and for a flow velocity of 15 m/s

**Shear Wave Transducers (extended temperature range)**

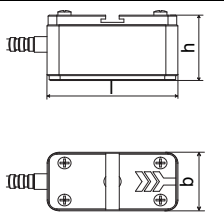
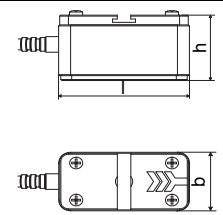
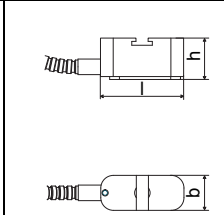
technical type		GDM1EZ7	GDP1EZ7	GDQ1EZ7
order code		<b>GSM-ENNNL</b>	<b>GSP-ENNNL</b>	<b>GSQ-ENNNL</b>
transducer frequency	MHz	1	2	4
<b>medium pressure<sup>1</sup></b>				
min. extended min.	bar bar	metal pipe: 20 metal pipe: 30 plastic pipe: 1	metal pipe: 20 metal pipe: 30 plastic pipe: 1	metal pipe: 20 metal pipe: 30 plastic pipe: 1
<b>inner pipe diameter d<sup>2</sup></b>				
min. extended	mm	30	15	6
min. recommended	mm	40	20	10
max. recommended	mm	80	40	20
max. extended	mm	120	60	30
<b>pipe wall thickness</b>				
min.	mm	2.5	1.5	1
max.	mm	-	-	-
<b>material</b>				
housing		stainless steel 304 (1.4301)	stainless steel 304 (1.4301)	stainless steel 304 (1.4301)
contact surface		Sintimid	Sintimid	Sintimid
degree of protection according to IEC/EN 60529		IP65	IP65	IP65
<b>transducer cable</b>				
type		1699	1699	1699
length	m	4	4	3
<b>dimensions</b>				
length l	mm	60	60	42.5
width b	mm	30	30	18
height h	mm	33.5	33.5	21.5
dimensional drawing				
<b>ambient temperature</b>				
min.	°C	-30	-30	-30
max.	°C	+200	+200	+200
temperature compensation		x	x	x

<sup>1</sup> depending on application, typical absolute value for natural gas, nitrogen, compressed air

<sup>2</sup> shear wave transducer:  
typical values for natural gas, nitrogen, oxygen, pipe diameters for other gases on request  
pipe diameter min. recommended/max. recommended/max. extended: in diagonal arrangement and for a flow velocity of 15 m/s

### Lamb Wave Transducers

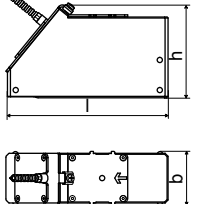
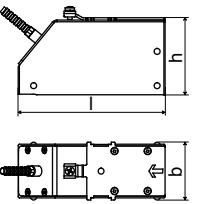
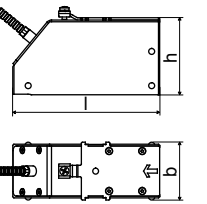
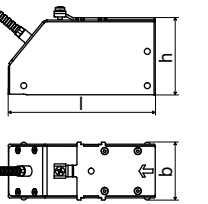
technical type		GRF1NC3	GRG1NC3	GRH1NC3	GRK1NC3
order code		<b>GLF-NNNNL</b>	<b>GLG-NNNNL</b>	<b>GLH-NNNNL</b>	<b>GLK-NNNNL</b>
transducer frequency	MHz	0.15	0.2	0.3	0.5
<b>medium pressure<sup>1</sup></b>					
min. extended	bar	metal pipe: 10	metal pipe: 10	metal pipe: 10	metal pipe: 10 (d > 120 mm) 3 (d < 120 mm)
min.	bar	metal pipe: 15 plastic pipe: 1	metal pipe: 15 plastic pipe: 1	metal pipe: 15 plastic pipe: 1	metal pipe: 15 (d > 120 mm) 10 (d < 120 mm) plastic pipe: 1
<b>inner pipe diameter d<sup>2</sup></b>					
min. extended	mm	230	190	120	60
min. recommended	mm	270	220	140	80
max. recommended	mm	1200	900	600	300
max. extended	mm	2100	1600	1000	500
<b>pipe wall thickness</b>					
min.	mm	14	11	7	4
max.	mm	30	23	15	9
max. extended	mm	35	-	-	-
<b>material</b>					
housing		PPSU with stainless steel cap 316Ti (1.4571)	PPSU with stainless steel cap 304 (1.4301)	PPSU with stainless steel cap 304 (1.4301)	PPSU with stainless steel cap 304 (1.4301)
contact surface		PPSU	PPSU	PPSU	PPSU
degree of protection according to IEC/ EN 60529		IP65	IP65	IP65	IP65
<b>transducer cable</b>					
type		1699	1699	1699	1699
length	m	5	5	5	5
<b>dimensions</b>					
length l	mm	163	128.5	128.5	128.5
width b	mm	54	51	51	51
height h	mm	91.3	67.5	67.5	67.5
dimensional drawing					
<b>ambient temperature</b>					
min.	°C	-40	-40	-40	-40
max.	°C	+170	+170	+170	+170
temperature compensation		x	x	x	x

<sup>1</sup> depending on application, typical absolute value for natural gas, nitrogen, compressed air

<sup>2</sup> Lamb wave transducer:

typical values for natural gas, nitrogen, oxygen, pipe diameters for other gases on request  
 pipe diameter min. recommended/max. recommended: in reflection arrangement and for a flow velocity of 15 m/s  
 pipe diameter max. extended: in diagonal arrangement and for a flow velocity of 25 m/s

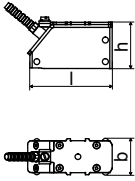
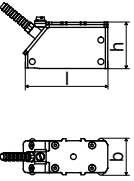
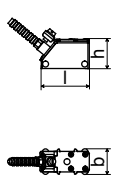
technical type		GRM1NC3	GRP1NC3	GRQ1NC3
order code		<b>GLM-NNNNL</b>	<b>GLP-NNNNL</b>	<b>GLQ-NNNNL</b>
transducer frequency	MHz	1	2	4
<b>medium pressure<sup>1</sup></b>				
min. extended	bar	metal pipe: 3 (d < 60 mm)	metal pipe: 3 (d < 35 mm)	metal pipe: 3 (d < 15 mm)
min.	bar	metal pipe: 10 (d > 60 mm) 5 (d < 60 mm) plastic pipe: 1	metal pipe: 10 (d > 35 mm) 5 (d < 35 mm) plastic pipe: 1	metal pipe: 10 (d > 15 mm) 5 (d < 15 mm) plastic pipe: 1
<b>inner pipe diameter d<sup>2</sup></b>				
min. extended	mm	30	15	7
min. recommended	mm	40	20	10
max. recommended	mm	90	50	22
max. extended	mm	150	70	35
<b>pipe wall thickness</b>				
min.	mm	2	1	0.5
max.	mm	5	3	1
<b>material</b>				
housing		PPSU with stainless steel cap 304 (1.4301)	PPSU with stainless steel cap 304 (1.4301)	PPSU with stainless steel cap 304 (1.4301)
contact surface		PPSU	PPSU	PPSU
degree of protection according to IEC/EN 60529		IP65	IP65	IP65
<b>transducer cable</b>				
type		1699	1699	1699
length	m	4	4	3
<b>dimensions</b>				
length l	mm	74	74	42
width b	mm	32	32	22
height h	mm	40.5	40.5	25.5
dimensional drawing				
<b>ambient temperature</b>				
min.	°C	-40	-40	-40
max.	°C	+170	+170	+170
temperature compensation		x	x	x

<sup>1</sup> depending on application, typical absolute value for natural gas, nitrogen, compressed air

<sup>2</sup> Lamb wave transducer:  
 typical values for natural gas, nitrogen, oxygen, pipe diameters for other gases on request  
 pipe diameter min. recommended/max. recommended: in reflection arrangement and for a flow velocity of 15 m/s  
 pipe diameter max. extended: in diagonal arrangement and for a flow velocity of 25 m/s

## Transducer Mounting Fixture

### Order Code

1, 2	3	4	5	6	7...9	no. of character		
transducer mounting fixture	transducer	-	measurement arrangement	size	-	fixation	outer pipe diameter	description
VP								portable Variofix
TB								tension belts
	A							all transducers
		D						reflection arrangement or diagonal arrangement
		R						reflection arrangement
			S					small
			M					medium
					C			chains
					G			tension belts
					N			without fixation
						055		10...550 mm
						150		50...1500 mm
						210		50...2100 mm
example								
VP	A	-	D	M	-	C	055	portable Variofix and chains
		-			-			

**portable Variofix VP and chains**

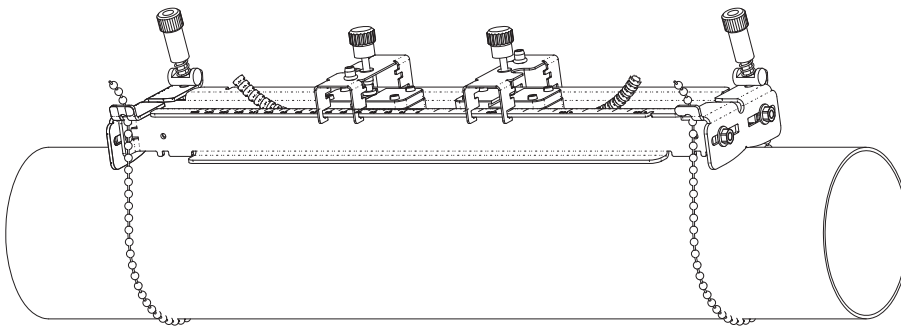

material: stainless steel 304 (1.4301), 301 (1.4310), 303 (1.4305)  
 dimensions: 414 x 94 x 76 mm  
 chain length: 2 m

**portable Variofix VP and magnet (optional)**

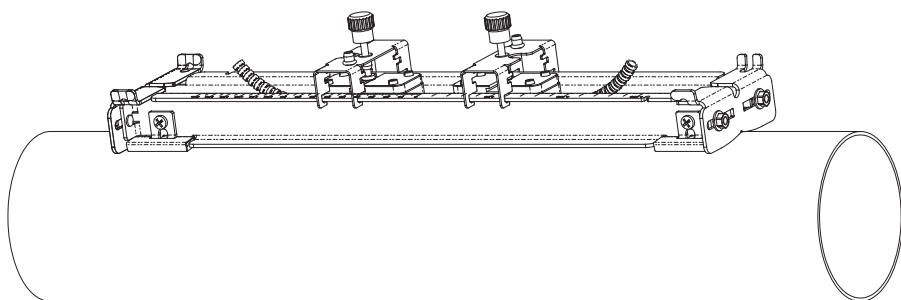

material: stainless steel 304 (1.4301), 301 (1.4310), 303 (1.4305)  
 dimensions: 414 x 94 x 40 mm

**portable Variofix VP and tension belts**

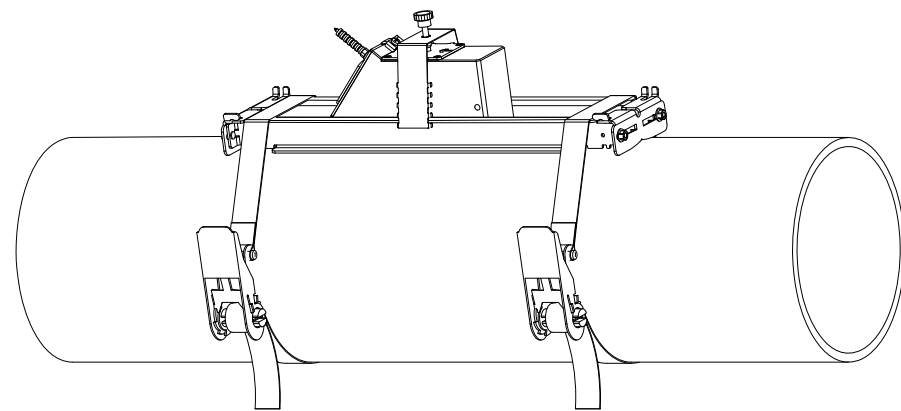

**tension belts TB**

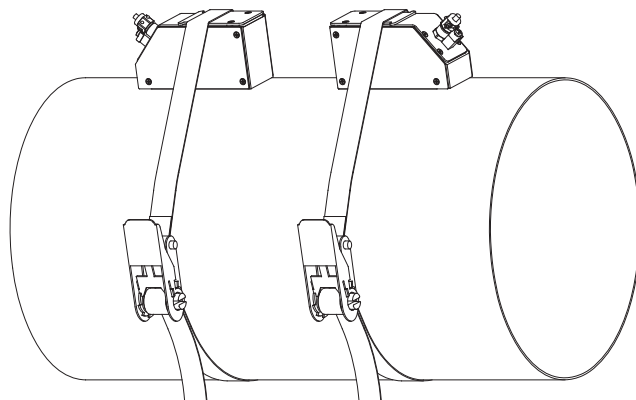

material: steel, powder coated and textile tension belt  
 length: 5/7 m

ambient temperature: max. 60 °C  
 outer pipe diameter: max. 1500/2100 mm

## Coupling Materials for Transducers

normal temperature range (4th character of transducer order code = N)		extended temperature range (4th character of transducer order code = E)	
< 100 °C	< 170 °C	< 150 °C	< 200 °C
coupling compound type N	coupling compound type E	coupling compound type E	coupling compound type E or H

## Technical Data

type	order code	ambient temperature °C	material
coupling compound type N	990739-1	-30...+130	mineral grease paste
coupling compound type E	990739-2	-30...+200	silicone paste
coupling compound type H	990739-3	-30...+250	fluoropolymer paste





## Connection Systems

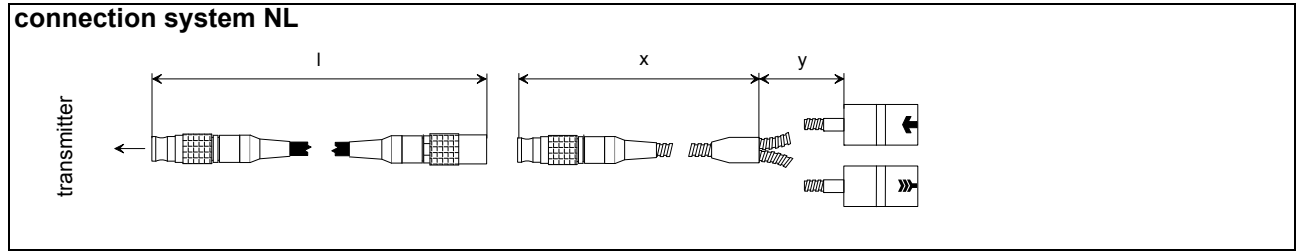

transducer frequency (3d character of transducer order code)		F, G, H, K			M, P			Q			S			
<b>N</b>	cable length	m	<b>x</b> 2	<b>y</b> 3	<b>l</b> <sup>1</sup> ≤ 25	<b>x</b> 2	<b>y</b> 2	<b>l</b> <sup>1</sup> ≤ 25	<b>x</b> 2	<b>y</b> 1	<b>l</b> <sup>1</sup> ≤ 25	<b>x</b> 1	<b>y</b> 1	<b>l</b> ≤ 20
<b>L</b>														

<sup>1</sup> > 25...100 m on request

x, y - transducer cable length

l - max. length of extension cable

## Transducer Cable

### Technical Data

		transducer cable		extension cable	
type		1699	2551	1750	
standard length	m	see table above	-	5 10	
max. length	m	-	see table above	10	
ambient temperature	°C	-55...+200	-25...+80	< 80	
<b>cable jacket</b>					
material		PTFE	TPE-O	PE	
outer diameter	mm	2.9	8	6	
thickness	mm	0.3		0.5	
colour		brown	black	black	
shield		x	x	x	
<b>sheath</b>					
material		stainless steel 304 (1.4301)	-	-	
outer diameter	mm	8	-	-	

## Clamp-on Temperature Probe (optional)

### Technical Data

technical type		<b>PT12N</b>	<b>PT12N</b>	<b>PT12F</b>	<b>PT12F</b>
order code		<b>670415-1</b>	<b>670414-1</b>	<b>670415-2</b>	<b>670414-2</b>
design				short response time	
type		Pt100	2x Pt100 matched according to EN 1434-1	Pt100	2x Pt100 matched according to EN 1434-1
connection		4-wire		4-wire	
measuring range	°C	-30...+250		-50...+250	
accuracy T		$\pm(0.15 \text{ °C} + 2 \cdot 10^{-3} \cdot  T \text{ [°C]} )$ , class A		$\pm(0.15 \text{ °C} + 2 \cdot 10^{-3} \cdot  T \text{ [°C]} )$ , class A	
accuracy ΔT		-	$\leq 0.1 \text{ K}$ (3 K < ΔT < 6 K), more corresponding to EN 1434-1	-	$\leq 0.1 \text{ K}$ (3 K < ΔT < 6 K), more corresponding to EN 1434-1
response time	s	50		8	
housing		aluminum		PEEK, stainless steel 304 (1.4301), copper	
degree of protection according to IEC/EN 60529		IP66		IP66	
weight (without connector)	kg	0.25	0.5	0.32	0.64
fixation		clamp-on		clamp-on	
<b>accessories</b>					
thermal conductivity paste 200 °C		x		x	
thermal conductivity foil 250 °C		x		x	
plastic protection plate, insulation foam		-		x	
<b>dimensions</b>					
length l	mm	15		14	
width b	mm	15		30	
height h	mm	20		27	
dimensional drawing		A		B	

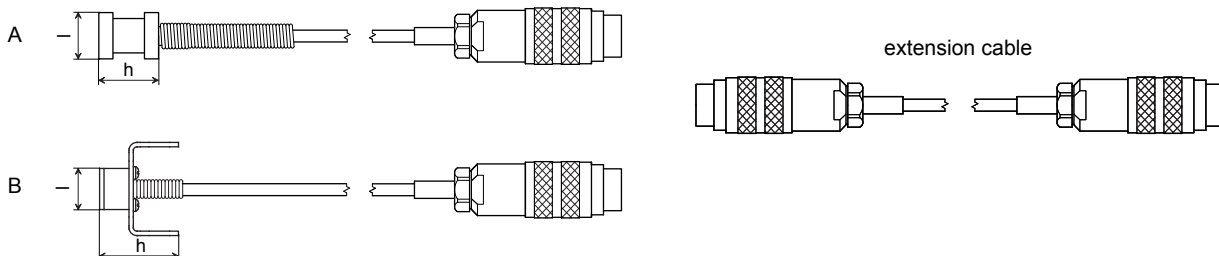

### Connection

#### Temperature Probe

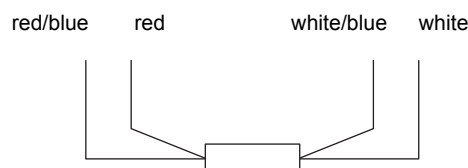

#### Connector

pin	cable of temperature probe	extension cable
1	white/blue	blue
2	red/blue	grey
3, 4, 5	not connected	
6	red	red
7	white	white
8	not connected	

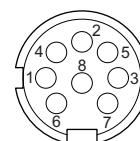

#### Cable

		cable of temperature probe	extension cable
type		4 x 0.25 mm <sup>2</sup> black or white	LIYCY 8 x 0.14 mm <sup>2</sup> grey
standard length	m	3	5/10/25
max. length	m	-	200
cable jacket		PTFE	PVC

### Wall Thickness Measurement (optional)

The pipe wall thickness is an important pipe parameter which has to be determined exactly for a good measurement. However, the pipe wall thickness often is unknown.

The wall thickness probe can be connected to the transmitter instead of the flow transducers and the wall thickness measurement mode is activated automatically.

Acoustic coupling compound is applied to the wall thickness probe which then is placed firmly on the pipe. The wall thickness is displayed and can be stored directly in the transmitter.

### Technical Data

technical type		DWR1NZ7
measuring range <sup>1</sup>	mm	1...250
resolution	mm	0.01
accuracy		1 % ± 0.1 mm
medium temperature	°C	-20...+200, short-time peak max. 500
<b>cable</b>		
type		2616
length	m	1.5

<sup>1</sup> The measuring range depends on the attenuation of the ultrasonic signal in the pipe. For strongly attenuating plastics (e.g. PFA, PTFE, PP) the measuring range is smaller.

### Cable

type		2616
ambient temperature	°C	<200
<b>cable jacket</b>		
material		FEP
outer diameter	mm	5.1
colour		black
shield		x

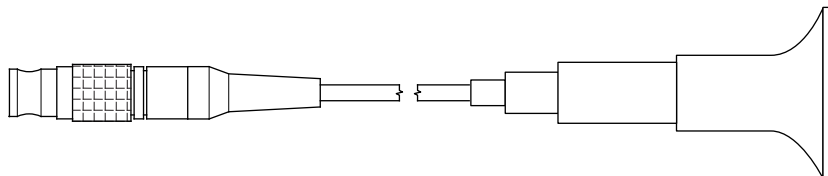

DWR1NZ7



FLEXIM GmbH  
Wolfener Str. 36  
12681 Berlin  
Germany  
Tel.: +49 (30) 93 66 76 60  
Fax: +49 (30) 93 66 76 80

internet: [www.flexim.com](http://www.flexim.com)  
e-mail: [info@flexim.com](mailto:info@flexim.com)

Subject to change without notification. Errors excepted.  
FLUXUS® is a registered trademark of FLEXIM GmbH.

TSFLUXUS\_G601V1-7-1EN\_Leu, 2015-11-25