

Portable Ultrasonic Flow Measurement of Gas in Hazardous Areas

Portable instrument for non-invasive, quick ultrasonic flow measurement with clamp-on technology for all types of piping

Features

- Precise bi-directional and highly dynamic flow measurement with the non-intrusive clamp-on technology
- High precision at fast and slow flow rates, high temperature and zero point stability
- Portable, easy-to-use flow transmitter with 2 flow channels, multiple inputs/outputs, an integrated data logger with a serial interface
- Extremely resistant carbon fiber housing
- Covered by ATEX/IECEX zone 2 certification
- Compact and very lightweight, allowing the measuring system to be easily carried as personal luggage, e.g. for offshore visits
- Water tight; resistant against oil, many liquids and dirt
- Li-Ion battery provides up to 14 hours of measurement operation
- Automatic loading of calibration data and transducer detection for a fast and easy set-up (less than 5 min), providing precise and long-term stable results
- User-friendly design
- Transducers available for a wide range of inner pipe diameters (6...1600 mm) and fluid temperatures (-40...+200 °C)
- Rugged transducers (ATEX/IECEX zone 1 and 2, resistant to rough environments, dust and humidity)
- Robust, water-tight (IP67) transport case with comprehensive accessories
- QuickFix for fast mounting of the flow transmitter in difficult conditions

Applications

Designed for the following industries:

- Upstream (on- and offshore)
- Midstream and downstream (pipelines and refineries)
- Chemical industry
- Energy sector (e.g. HVAC, geothermal, power plants)



FLUXUS G608 supported by handle



Measurement with transducers mounted by the portable Variofix VP



Measurement with the flow transmitter fixed to the pipe by the QuickFix pipe mounting fixture

Table of Contents

Function	3
Measurement Principle	3
Calculation of Volumetric Flow Rate	3
Number of Sound Paths	4
Typical Measurement Setup	5
Standard Volumetric Flow Rate	6
Flow Transmitter	7
Technical Data	7
Dimensions	9
Standard Scope of Supply	9
Adapters (optional).....	10
Transducers	12
Transducer Selection	12
Transducer Order Code	15
Technical Data	16
Transducer Mounting Fixture	26
Coupling Materials for Transducers	27
Damping Mats (optional)	28
Connection Systems	29
Transducer Cable.....	29
Clamp-on Temperature Probe (optional)	30
Wall Thickness Measurement (optional)	31

Function

Measurement Principle

In order to measure the flow of a medium in a pipe, ultrasonic signals are used, employing the transit time difference principle. Ultrasonic signals are emitted by a transducer installed on the pipe and received by a second transducer. These signals are emitted alternately in the flow direction and against it.

As the medium in which the signals propagate is flowing, the transit time of the ultrasonic signals in the flow direction is shorter than against the flow direction.

The transit time difference, Δt , is measured and allows the flowmeter to determine the average flow velocity along the propagation path of the ultrasonic signals. A flow profile correction is then performed in order to obtain the area averaged flow velocity, which is proportional to the volumetric flow rate.

Two integrated microprocessors control the entire measuring process. This allows the flowmeter to remove disturbance signals, and to check each received ultrasonic wave for its validity which reduces noise.

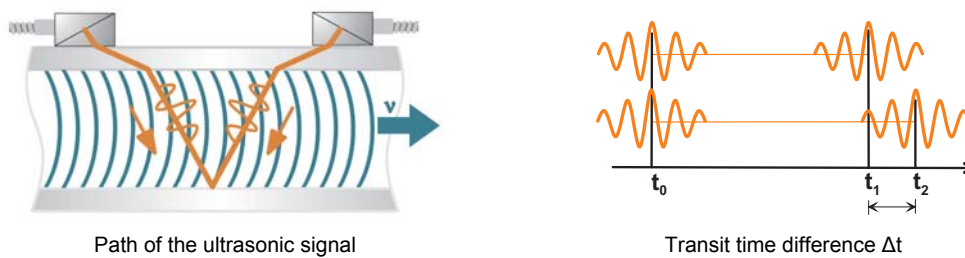

Calculation of Volumetric Flow Rate

$$\dot{V} = k_{Re} \cdot A \cdot k_a \cdot \Delta t / (2 \cdot t_{fl})$$

where

- \dot{V} - volumetric flow rate
- k_{Re} - fluid mechanics calibration factor
- A - cross-sectional pipe area
- k_a - acoustical calibration factor
- Δt - transit time difference
- t_{fl} - transit time in the medium

Number of Sound Paths

The number of sound paths is the number of transits of the ultrasonic signal through the medium in the pipe. Depending on the number of sound paths, the following methods of installation exist:

- **reflection arrangement**

The number of sound paths is even. Both of the transducers are mounted on the same side of the pipe. Correct positioning of the transducers is easier.

- **diagonal arrangement**

The number of sound paths is odd. Both of the transducers are mounted on opposite sides of the pipe. In the case of a high signal attenuation by the medium, pipe and coatings, diagonal arrangement with 1 sound path will be used.

The preferred method of installation depends on the application. While increasing the number of sound paths increases the accuracy of the measurement, signal attenuation increases as well. The optimum number of sound paths for the parameters of the application will be determined automatically by the transmitter.

As the transducers can be mounted with the transducer mounting fixture in reflection arrangement or diagonal arrangement, the number of sound paths can be adjusted optimally for the application.

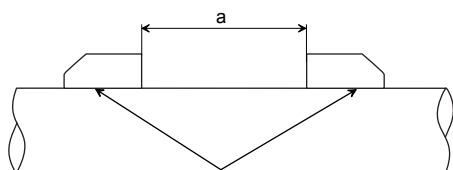

a - transducer distance

Reflection arrangement, number of sound paths: 2

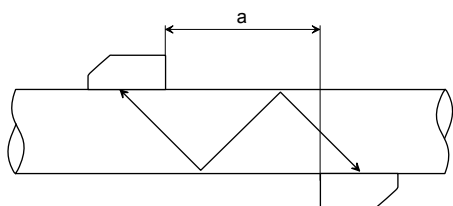

Diagonal arrangement, number of sound paths: 3

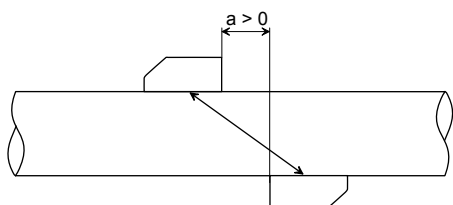

Diagonal arrangement, number of sound paths: 1

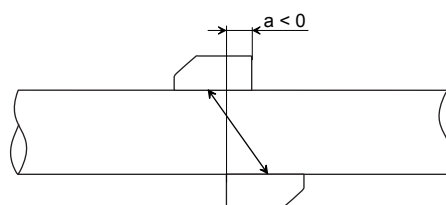

Diagonal arrangement, number of sound paths: 1, negative transducer distance

Typical Measurement Setup

ATEX zone 2

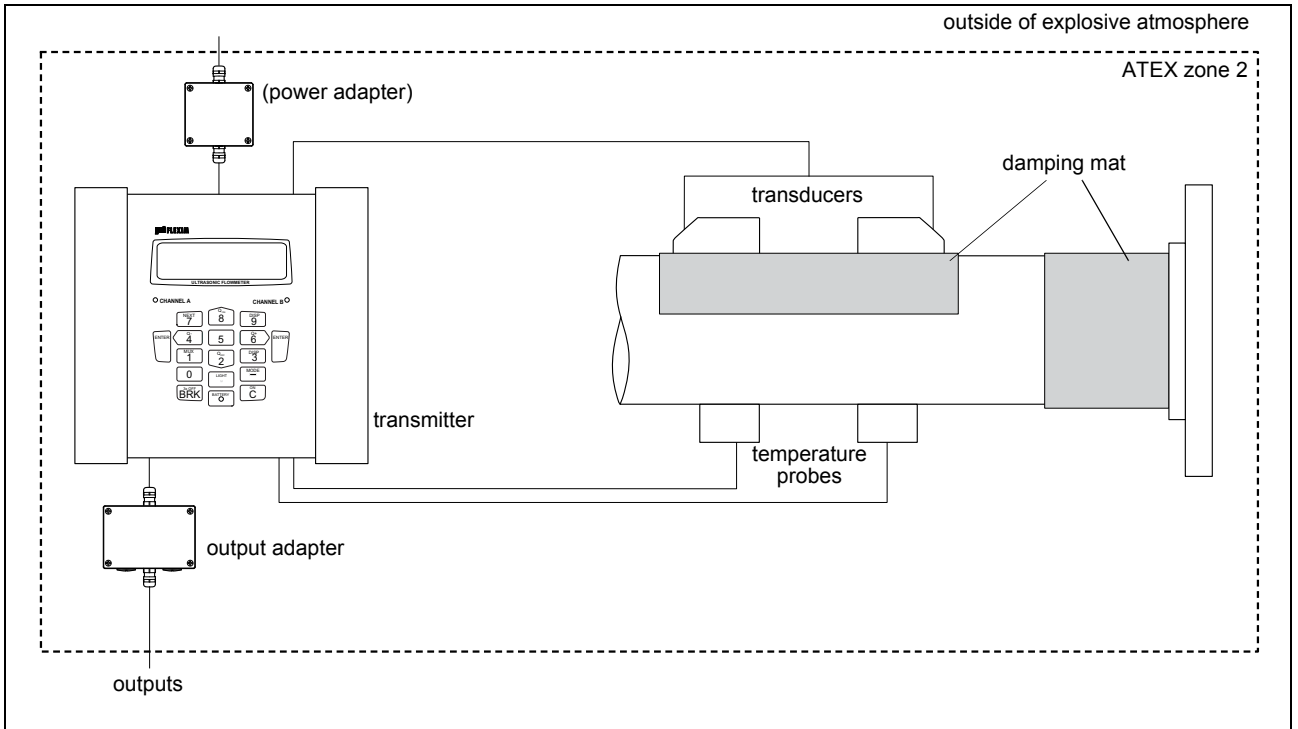

ATEX zone 2/ATEX zone 1

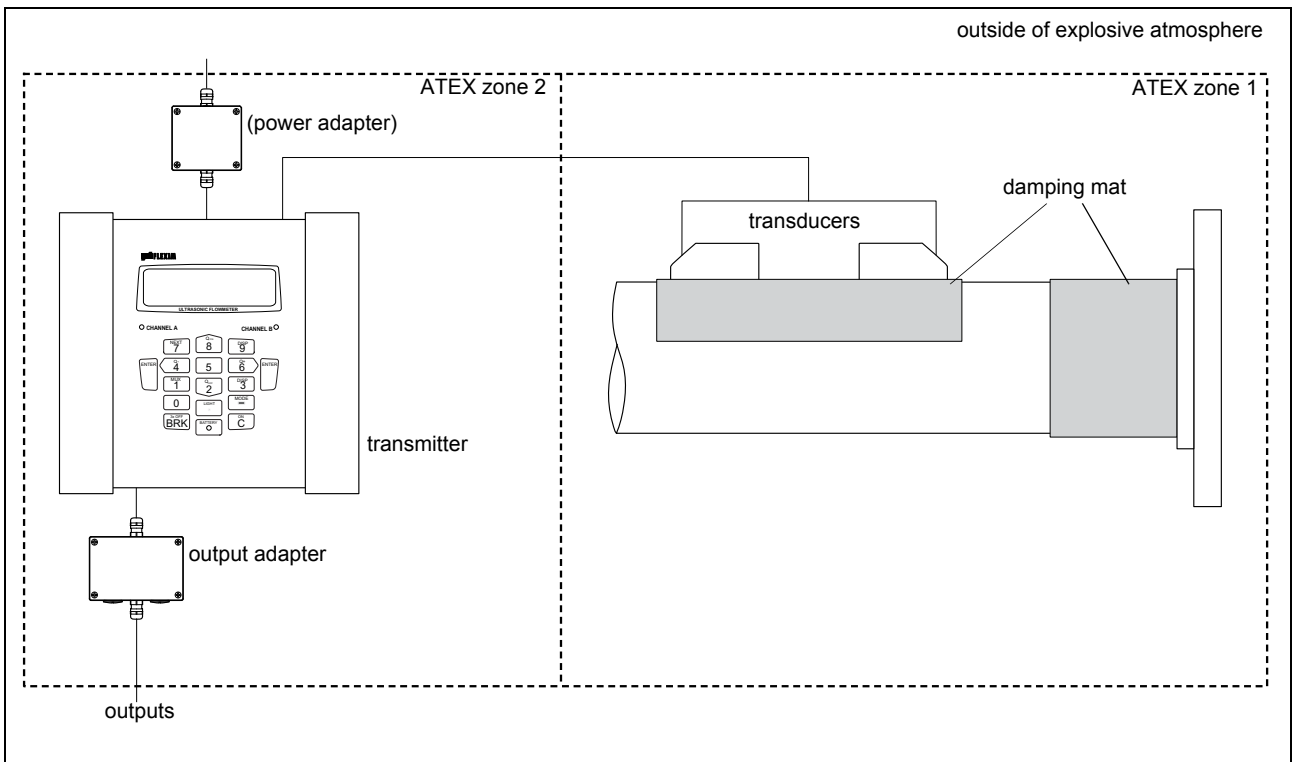

Standard Volumetric Flow Rate

The standard volumetric flow rate can be selected as physical quantity to be measured. It will be calculated internally by:

$$\dot{V}_N = \dot{V} \cdot p/p_N \cdot T_N/T \cdot 1/K$$

where

\dot{V}_N	-	standard volumetric flow rate
\dot{V}	-	operating volumetric flow rate
p_N	-	standard pressure (absolute value)
p	-	operating pressure (absolute value)
T_N	-	standard temperature in K
T	-	operating temperature in K
K	-	compressibility coefficient of the gas: ratio of the compressibility factors of the gas at operating conditions and at standard conditions Z/Z_N

The operational pressure p and the operational temperature T of the medium will be entered directly as fixed values into the transmitter.

or:

If inputs are installed (optional), pressure and temperature can be measured by the customer and fed in the transmitter.

The gas compressibility coefficient K of the gas is entered in the transmitter:

- as fixed value or
- as approximation according to e.g. AGA8 or GERG

Flow Transmitter

Technical Data

FLUXUS		G608**-A2	
design	portable, ATEX zone 2		
			
measurement			
measurement principle	transit time difference correlation principle		
flow velocity	0.01...35 m/s, depending on pipe diameter		
repeatability	0.15 % of reading ±0.01 m/s		
medium	all acoustically conductive gases, e.g. nitrogen, air, oxygen, hydrogen, argon, helium, ethylene, propane		
temperature compensation	corresponding to the recommendations in ANSI/ASME MFC-5.1-2011		
accuracy			
volumetric flow rate	± 1...3 % of reading ±0.01 m/s depending on application ± 0.5 % of reading ±0.01 m/s with field calibration		
flow transmitter			
power supply	100...240 V/50...60 Hz (power supply unit, outside of explosive atmosphere), 10.5...15 V DC (socket at transmitter, with power adapter (optional)), integrated battery		
battery	Li-Ion, 7.2 V/4.5 Ah operating time (without outputs, inputs and backlight): > 14 h		
power consumption	< 6 W		
number of flow measuring channels	2		
signal attenuation	0...100 s, adjustable		
measuring cycle (1 channel)	100...1000 Hz		
response time	1 s (1 channel), option: 70 ms		
housing material	PA, TPS, PC, Polyester, stainless steel		
degree of protection according to IEC/EN 60529	IP65		
dimensions	see dimensional drawing		
weight	1.9 kg		
fixation	QuickFix pipe mounting fixture		
ambient temperature	-10...+60 °C		
display	2 x 16 characters, dot matrix, backlight		
menu language	English, German, French, Dutch, Spanish		
explosion protection			
ATEX / IECEx	category	gas: 3G	dust: 2D
	EPL	Gc	Db
	zone	2	21
	marking	CE 0637 Ⓢ II3G II2D Ex nA nC [ic] IIC (T6)T4 Gc T _a -10...+(50)60 °C Ex tb IIIC T 100 °C Db	
	certification ATEX	IBExU10ATEX1067	
	certification IECEx	IECEx IBE 12.0006	
	type of protection	gas: non sparking dust: protection by enclosure temperature inputs: intrinsic safety	
	intrinsic safety parameters	U _m = 16 V DC intrinsically safe inputs: U _o = 22 V, I _o = 6 mA, P _o = 33 mW, C _o = 450 nF, L _o = 10 mH, C _i = 1.8 nF, L _i = 10 µH	

FLUXUS	G608**-A2
measuring functions	
physical quantities	operating volumetric flow rate, standard volumetric flow rate, mass flow rate, flow velocity
totalizer	volume, mass
calculation functions	average, difference, sum
diagnostic functions	sound speed, signal amplitude, SNR, SCNR, standard deviation of amplitudes and transit times
data logger	
loggable values	all physical quantities, totalized values and diagnostic values
capacity	> 100 000 measured values
communication	
interface	RS232/USB
serial data kit	
software (all Windows™ versions)	- FluxData: download of measurement data, graphical presentation, conversion to other formats (e.g. for Excel™) - FluxKoef: creating medium data sets - FluxSubstanceLoader: upload of medium data sets
cable	RS232
adapter	RS232 - USB
transport case	
dimensions	500 x 400 x 190 mm
outputs	
	The outputs are galvanically isolated from the transmitter.
number	max. 4
- analog outputs	0, 2 or 4 active current outputs or passive current outputs or frequency outputs or 2 active current outputs and 2 passive current outputs or 2 active current outputs and 2 frequency outputs or 2 passive current outputs and 2 frequency outputs
- binary outputs	max. 4
accessories	output adapter (necessary, option)
current output	
range	0/4...20 mA
accuracy	0.1 % of reading ±15 µA
active output	$R_{ext} < 200 \Omega$
passive output	$U_{ext} = 4...9 \text{ V}$, depending on R_{ext} $R_{ext} < 200 \Omega$
frequency output	
range	0...5 kHz
open collector	24 V/4 mA
binary output	
optorelay	26 V/100 mA
binary output as alarm output	
- functions	limit, change of flow direction or error
binary output as pulse output	
- pulse value	0.01...1000 units
- pulse width	1...1000 ms
inputs	
	The inputs are galvanically isolated from the transmitter.
number	max. 4
accessories	input adapter (if number of inputs > 2)
temperature input (intrinsic safety)	
type	Pt100/Pt1000
connection	4-wire
range	-150...+560 °C
resolution	0.01 K
accuracy	±0.01 % of reading ±0.03 K

Dimensions

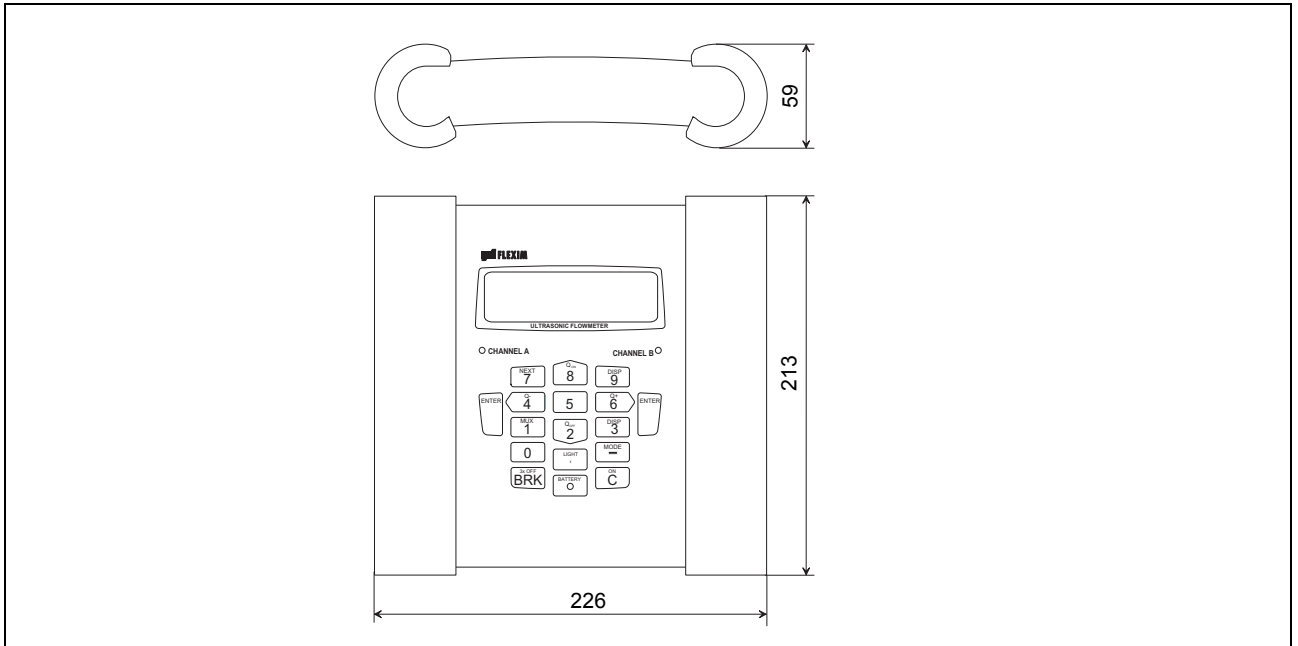

in mm

Standard Scope of Supply

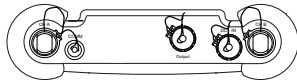
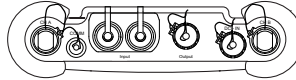
	G608 Standard	G608 CA-Energy
order code	FLUXUS G608ST-A22-3N-NN-2D-II-NN-NN	FLUXUS G608ST-A22-3N-GG-2D-II-GG-NN
application	flow measurement on gas	flow measurement on compressed air, industrial gases and liquids
	2 independent measuring channels	
	calculation of standard volumetric flow rate	calculation of standard volumetric flow rate, with optional use of current measured temperature values
		liquids: integrated heat flow computer for monitoring of energy flows
transducer frequency	G, H, K, M, P	K, M, P, Q, S
outputs		
passive current output	2	2
binary output	2	2
inputs		
temperature input	-	4
accessories		
transport case	x	x
power supply unit, mains cable	x	x
battery	x	x
power adapter ¹	-	-
output adapter ¹	-	-
input adapter	-	2
QuickFix pipe mounting fixture for transmitter	x	x
serial data kit	x	x
measuring tape	x	x
wall thickness probe	-	x
user manual, safety instructions, Quick Start Guide	x	x
connector board at the upper side of the transmitter		

¹ if required, to be ordered separately

Adapters (optional)

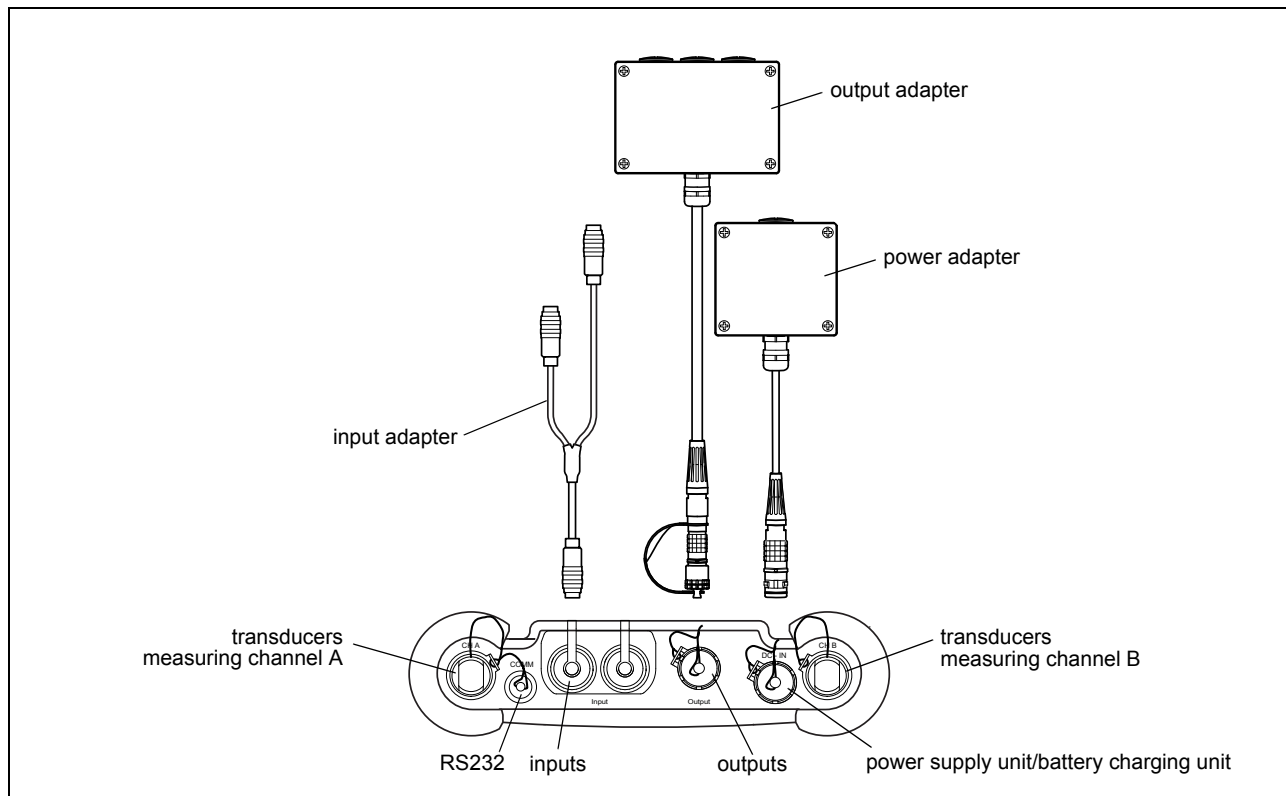

Technical Data

		output adapter	power adapter
technical type		OA608A2	PA608A2
connection voltage			10.5...15 V DC
dimensions		see dimensional drawing	
weight	kg	0.36	0.29
material			
housing		polyester	
gasket		silicone	
degree of protection according to IEC/ EN 60529		IP66	
ambient temperature			
min.	°C	-20	
max.	°C	+90	
explosion protection			
A	zone	2	
T	marking	CE (Ex) II3G Ex nA IIC T6 Gc Ta -10...+60 °C	
X	type of protection	non sparking	

Dimensions

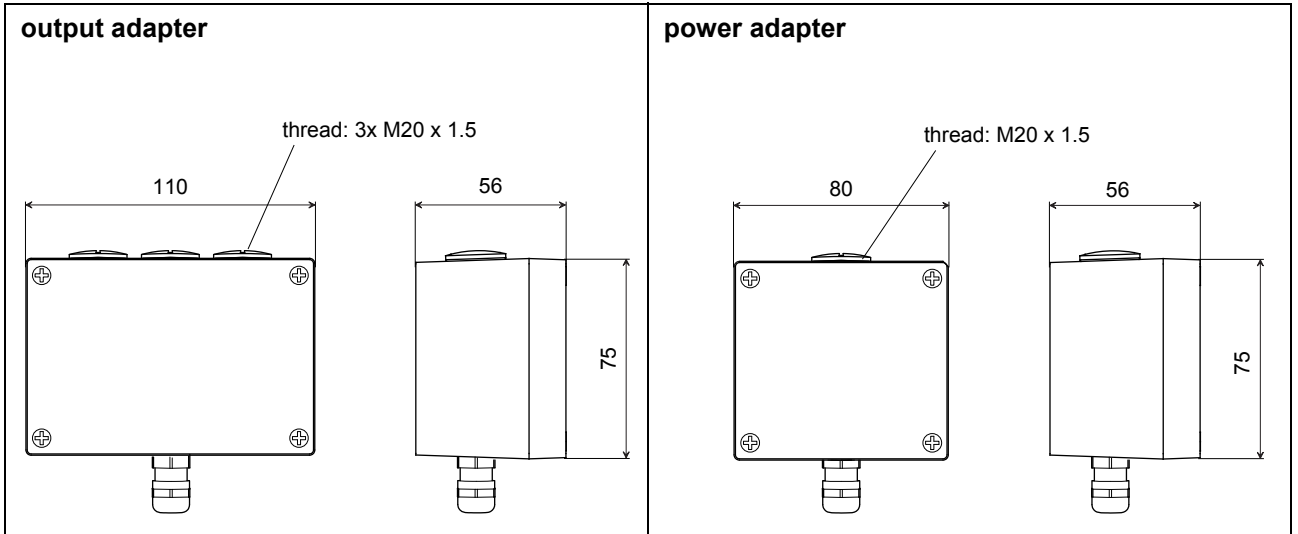

in mm

Terminal Assignment

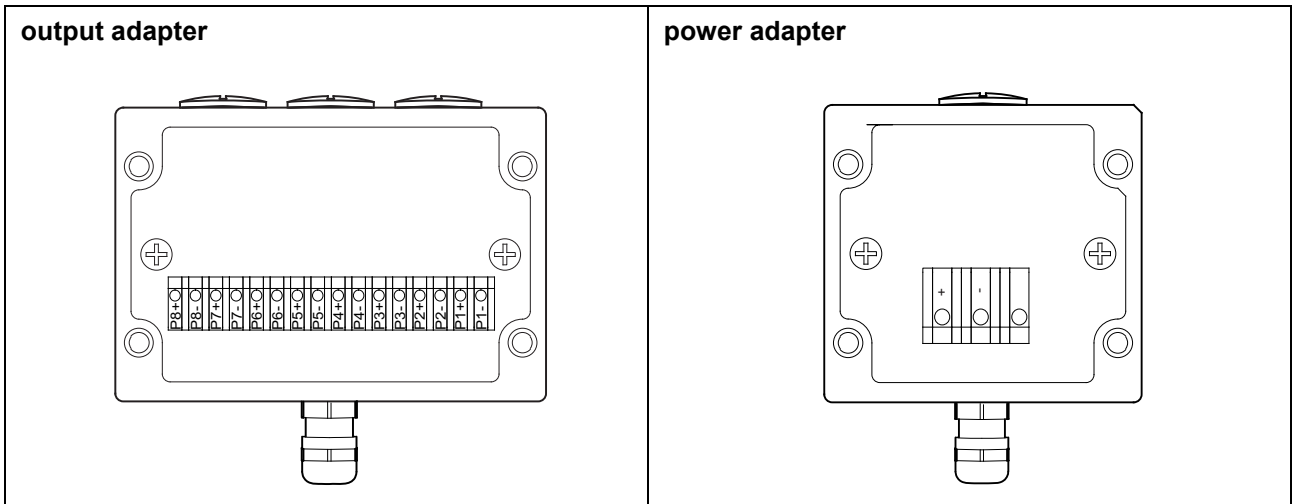

Transducers

Transducer Selection

Step 1a

Select a Lamb wave transducer:

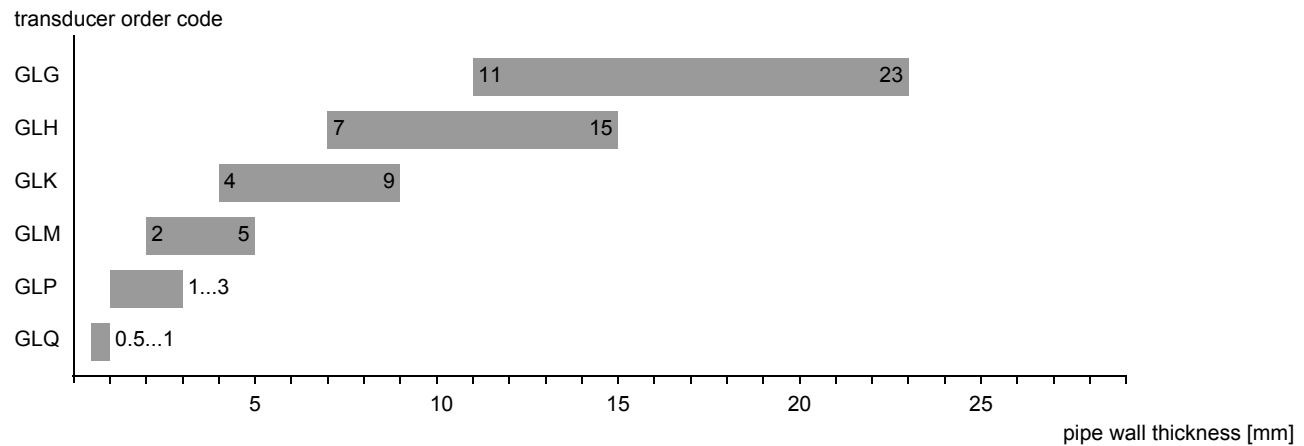

Step 1b

If the pipe wall thickness is not in the range of the Lamb wave transducers, select a shear wave transducer:

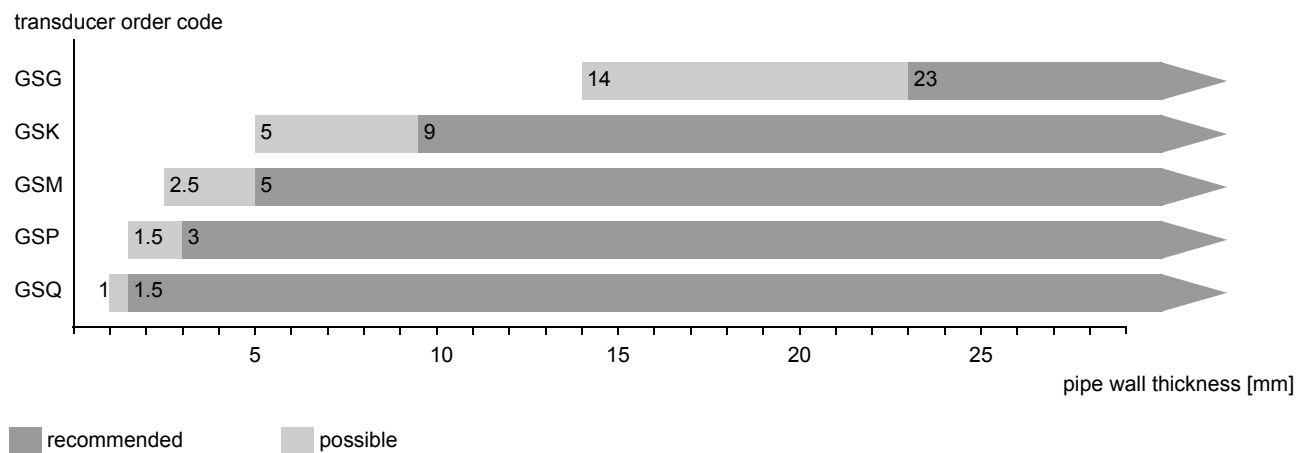

Step 2

inner pipe diameter d dependent on the flow velocity v of the medium in the pipe

The transducers are selected from the characteristics (see next page). Lamb wave transducers are selected from the left column, shear wave transducers from the right column.

Lamb wave transducers: If the values d and v are not in the range, the diagonal arrangement with 1 sound path may be used, i.e. the same characteristics can be used with doubling the inner pipe diameter. If the values are still not in the range, shear waves transducers regarding the pipe wall thickness have to be selected in step 1b.

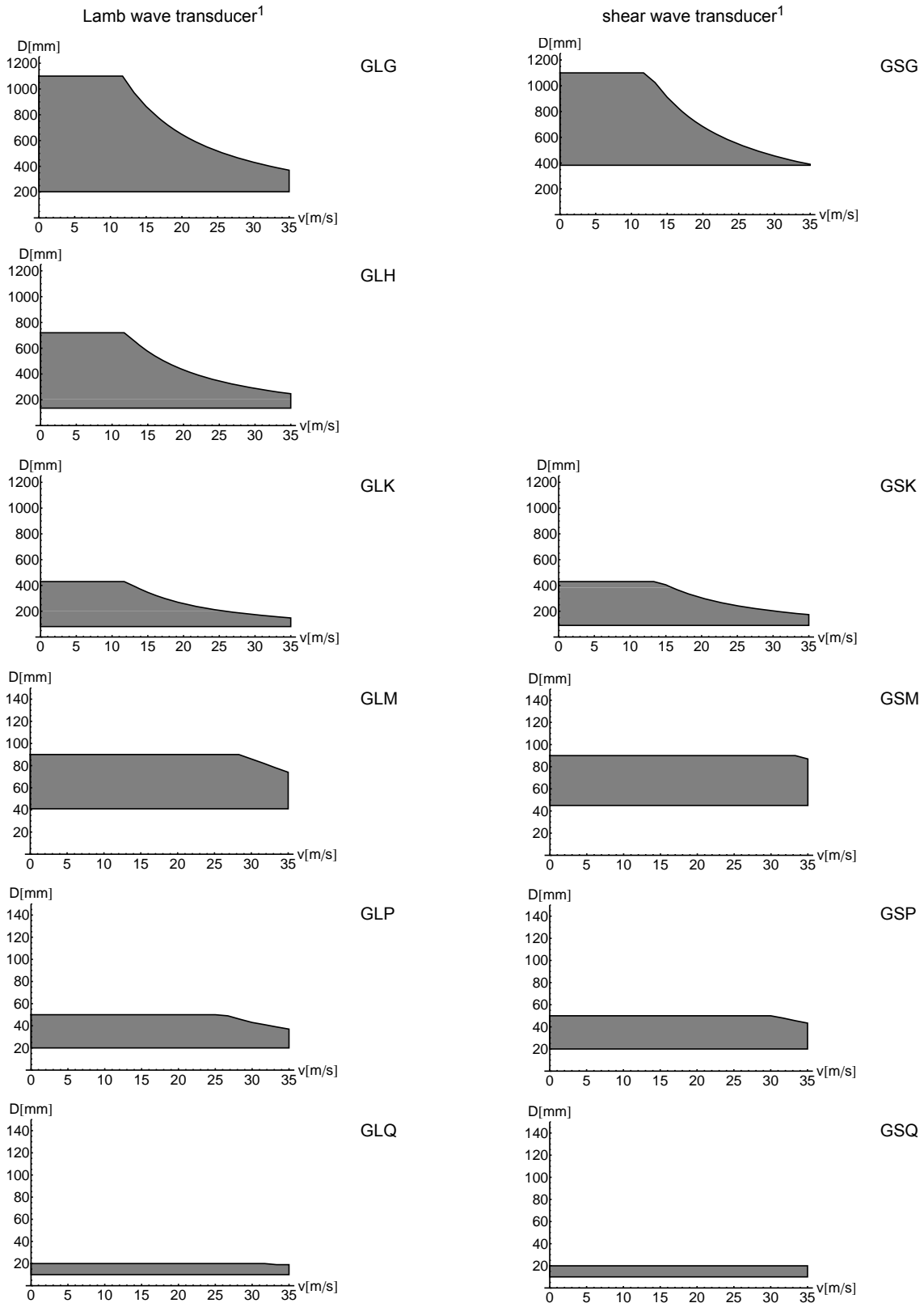

¹ inner pipe diameter and max. flow velocity for a typical application with natural gas, nitrogen, oxygen in reflection arrangement with 2 sound paths (Lamb wave transducers)/1 sound path (shear wave transducers)

Step 3

min. medium pressure

Lamb wave transducer			
transducer order code	medium pressure ¹ [bar]		
	metal pipe		plastic pipe
	min.	min. extended	min.
GLG	15	10	1
GLH	15	10	1
GLK	15 (d > 120 mm) 10 (d < 120 mm)	10 (d > 120 mm) 5 (d < 120 mm)	1
GLM	10 (d > 60 mm) 5 (d < 60 mm)	-	1
GLP	10 (d > 35 mm) 5 (d < 35 mm)	-	1
GLQ	10 (d > 15 mm) 5 (d < 15 mm)	-	1

shear wave transducer			
transducer order code	medium pressure ¹ [bar]		
	metal pipe		plastic pipe
	min.	min. extended	min.
GSG	30	20	1
GSK	30	20	1
GSM	30	20	1
GSP	30	20	1
GSQ	30	20	1

¹ depending on application, typical absolute value for natural gas, nitrogen, compressed air

d - inner pipe diameter

Example

step						
1	pipe wall thickness selected transducer	mm	12 GLG or GLH	12 GLG or GLH	12 GLG or GLH	30 GS
2	inner pipe diameter max. flow velocity selected transducer	mm m/s	800 15 GLG	600 15 GLG or GLH	800 30 values not in the range of the characteristics, but by using diagonal arrangement with 1 sound path, the inner pipe diameter in the characteristics is doubled: GLG	300 15 GSK
3	min. medium pressure selected transducer	bar	17 GLG	17 GLG or GLH influence of acoustic noise is reduced with increased transducer frequency, thus recommended: GLH	17 GLG	35 GSK

Step 4

for the characters 4...11 of the transducer order code (ambient temperature, explosion protection, connection system, extension cable) see page 15

Step 5



for the technical data of the selected transducer see page 16 et seqq.

Transducer Order Code

1, 2	3	4	5, 6	7, 8	9...11	12, 13	no. of character			
transducer	transducer frequency	-	ambient temperature	explosion protection	connection system	-	extension cable	/	option	description
GL										set of ultrasonic flow transducers for gas measurement, Lamb wave
GS										set of ultrasonic flow transducers for gas measurement, shear wave
	G									0.2 MHz
	H									0.3 MHz (Lamb wave only)
	K									0.5 MHz
	M									1 MHz
	P									2 MHz
	Q									4 MHz
			N							normal temperature range
			E							extended temperature range (shear wave transducers with transducer frequency M, P, Q)
				A1						ATEX zone 1/IECEX zone 1
				A2						ATEX zone 2/IECEX zone 2
					NL					with Lemo connector
							XXX			cable length in m, for max. length of extension cable see page 29 (connector outside of ATEX zone 1/IECEX zone 1)
								LC		long transducer cable (ATEX zone 1/IECEX zone 1)
example										
GL	K	-	N	A2	NL	-	010			Lamb wave transducer 0.5 MHz, normal temperature range, ATEX zone 2/IECEX zone 2, connection system NL with Lemo connector and extension cable 10 m
		-				-		/		

Technical Data

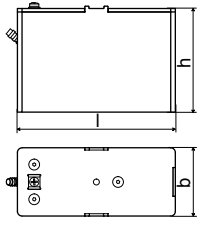
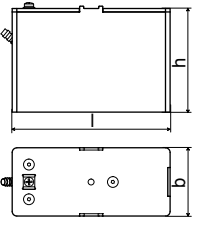
Shear Wave Transducers (zone 1)

technical type		GDG1NW1	GLG1NW1	GDK1NW1	GLK1NW1
order code		GSG-NA1NL	GSG-NA1NL/LC	GSK-NA1NL	GSK-NA1NL/LC
transducer frequency		MHz 0.2		0.5	
medium pressure¹					
min. extended min.		bar	metal pipe: 20 metal pipe: 30 plastic pipe: 1	bar	metal pipe: 20 metal pipe: 30 plastic pipe: 1
inner pipe diameter d²					
min. extended		mm	250	mm	70
min. recommended		mm	380	mm	80
max. recommended		mm	810	mm	500
max. extended		mm	1100	mm	720
pipe wall thickness					
min.		mm	14	mm	5
max.		mm	-	mm	-
material					
housing		PEEK with stainless steel cap and transducer shoe 304 (1.4301)		PEEK with stainless steel cap and transducer shoe 304 (1.4301)	
contact surface		PEEK		PEEK	
degree of protection according to IEC/EN 60529		IP65		IP65	
transducer cable					
type		1699	1699	1699	1699
length		m 5	9	m 5	9
dimensions					
length l		mm	136.5	mm	136.5
width b		mm	59	mm	59
height h		mm	90.5	mm	90.5
dimensional drawing					
ambient temperature					
min.		°C	-40	°C	-40
max.		°C	+130	°C	+130
temperature compensation		x		x	
explosion protection					
category		gas: 2/3G dust: 2D		gas: 2/3G dust: 2D	
EPL		Gb/Gc Db		Gb/Gc Db	
zone		1/2 21		1/2 21	
A					
explosion protection temperature (pipe surface)					
min.		°C	-55	°C	-55
max.		°C	+180	°C	+180
X		CE 0637  II2/3G II2D Ex q nA IIC T6...T2 Gb/Gc Ex tb IIIC TX Db		CE 0637  II2/3G II2D Ex q nA IIC T6...T2 Gb/Gc Ex tb IIIC TX Db	
/					
I					
E					
C		IBEXU10ATEX1162 X		IBEXU10ATEX1162 X	
E		IECEX IBE 12.0004X		IECEX IBE 12.0004X	
x		gas: powder filling, non sparking dust: protection by enclosure		gas: powder filling, non sparking dust: protection by enclosure	

¹ depending on application, typical absolute value for natural gas, nitrogen, compressed air

² shear wave transducer:

typical values for natural gas, nitrogen, oxygen, pipe diameters for other gases on request

pipe diameter min. recommended/max. recommended/max. extended: in diagonal arrangement and for a flow velocity of 15 m/s

Shear Wave Transducers (zone 1)

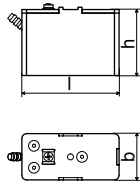
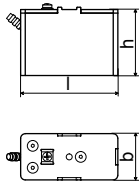
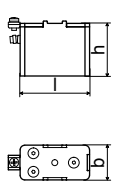
technical type		GDM2NW1	GLM2NW1	GDP2NW1	GLP2NW1	GDQ2NW1	GLQ2NW1
order code		GSM-NA1NL	GSM-NA1NL/LC	GSP-NA1NL	GSP-NA1NL/LC	GSQ-NA1NL	GSQ-NA1NL/LC
transducer frequency	MHz	1		2		4	
medium pressure¹							
min. extended min.	bar bar	metal pipe: 20 metal pipe: 30 plastic pipe: 1		metal pipe: 20 metal pipe: 30 plastic pipe: 1		metal pipe: 20 metal pipe: 30 plastic pipe: 1	
inner pipe diameter d²							
min. extended	mm	30		15		6	
min. recommended	mm	40		20		10	
max. recommended	mm	80		40		20	
max. extended	mm	120		60		30	
pipe wall thickness							
min.	mm	2.5		1.5		1	
max.	mm	-		-		-	
material							
housing		PEEK with stainless steel cap and transducer shoe 304 (1.4301)		PEEK with stainless steel cap and transducer shoe 304 (1.4301)		PEEK with stainless steel cap and transducer shoe 304 (1.4301)	
contact surface		PEEK		PEEK		PEEK	
degree of protection according to IEC/EN 60529		IP65		IP65		IP65	
transducer cable							
type		1699	1699	1699	1699	1699	1699
length	m	4	9	4	9	3	9
dimensions							
length l	mm	84		84		70	
width b	mm	40		40		30	
height h	mm	59		59		47.5	
dimensional drawing							
ambient temperature							
min.	°C	-40		-40		-40	
max.	°C	+130		+130		+130	
temperature compensation		x		x		x	
explosion protection							
category		gas: 2/3G dust: 2D		gas: 2/3G dust: 2D		gas: 2/3G dust: 2D	
EPL		Gb/Gc Db		Gb/Gc Db		Gb/Gc Db	
zone		1/2 21		1/2 21		1/2 21	
explosion protection temperature (pipe surface)							
min.	°C	-55		-55		-55	
max.	°C	+180		+180		+180	
marking		CE 0637 Ex q nA IIC T6...T2 Gb/Gc Ex tb IIIC TX Db		CE 0637 Ex q nA IIC T6...T2 Gb/Gc Ex tb IIIC TX Db		CE 0637 Ex q nA IIC T6...T2 Gb/Gc Ex tb IIIC TX Db	
certification ATEX		IBExU10ATEX1162 X		IBExU10ATEX1162 X		IBExU10ATEX1162 X	
certification IECEx		IECEX IBE 12.0004X		IECEX IBE 12.0004X		IECEX IBE 12.0004X	
type of protection		gas: powder filling, non sparking dust: protection by enclosure		gas: powder filling, non sparking dust: protection by enclosure		gas: powder filling, non sparking dust: protection by enclosure	
remark		on request					

¹ depending on application, typical absolute value for natural gas, nitrogen, compressed air

² shear wave transducer:

typical values for natural gas, nitrogen, oxygen, pipe diameters for other gases on request

pipe diameter min. recommended/max. recommended/max. extended: in diagonal arrangement and for a flow velocity of 15 m/s

Shear Wave Transducers (zone 1, extended temperature range)

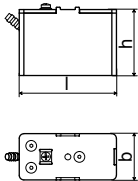
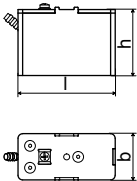
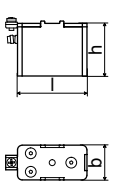
technical type		GDM2EW5	GLM2EW5	GDP2EW5	GLP2EW5	GDQ2EW5	GLQ2EW5
order code		GSM-EA1NL	GSM-EA1NL/LC	GSP-EA1NL	GSP-EA1NL/LC	GSQ-EA1NL	GSQ-EA1NL/LC
transducer frequency		MHz 1		2		4	
medium pressure¹							
min. extended min.		bar	metal pipe: 20 metal pipe: 30 plastic pipe: 1	metal pipe: 20 metal pipe: 30 plastic pipe: 1	metal pipe: 20 metal pipe: 30 plastic pipe: 1	metal pipe: 20 metal pipe: 30 plastic pipe: 1	
inner pipe diameter d²							
min. extended		mm	30	15	6		
min. recommended		mm	40	20	10		
max. recommended		mm	80	40	20		
max. extended		mm	120	60	30		
pipe wall thickness							
min.		mm	2.5	1.5	1		
max.		mm	-	-	-		
material							
housing			PI with stainless steel cap and transducer shoe 304 (1.4301)	PI with stainless steel cap and transducer shoe 304 (1.4301)	PI with stainless steel cap and transducer shoe 304 (1.4301)		
contact surface			PI	PI	PI		
degree of protection according to IEC/EN 60529			IP56	IP56	IP56		
transducer cable							
type			6111	6111	6111	6111	6111
length		m	4	9	4	9	3 9
dimensions							
length l		mm	84	84	70		
width b		mm	40	40	30		
height h		mm	59	59	47.5		
dimensional drawing							
ambient temperature							
min.		°C	-30	-30	-30		
max.		°C	+200	+200	+200		
temperature compensation			x	x	x		
explosion protection							
category			gas: 2/3G dust: 2D	gas: 2/3G dust: 2D	gas: 2/3G dust: 2D		
EPL			Gb/Gc Db	Gb/Gc Db	Gb/Gc Db		
zone			1/2 21	1/2 21	1/2 21		
explosion protection temperature (pipe surface)							
min.		°C	-45	-45	-45		
max.		°C	+225	+225	+225		
marking			CE 0637 Ex II2/3G IIB2D Ex q nA IIC T6...T2 Gb/Gc Ex tb IIIA TX Db	CE 0637 Ex II2/3G IIB2D Ex q nA IIC T6...T2 Gb/Gc Ex tb IIIA TX Db	CE 0637 Ex II2/3G IIB2D Ex q nA IIC T6...T2 Gb/Gc Ex tb IIIA TX Db		
certification ATEX			IBExU10ATEX1162 X	IBExU10ATEX1162 X	IBExU10ATEX1162 X		
certification IECEx			IECEx IBE 12.0004X	IECEx IBE 12.0004X	IECEx IBE 12.0004X		
type of protection			gas: powder filling, non sparking dust: protection by enclosure	gas: powder filling, non sparking dust: protection by enclosure	gas: powder filling, non sparking dust: protection by enclosure		
remark					on request		

¹ depending on application, typical absolute value for natural gas, nitrogen, compressed air

² shear wave transducer:
typical values for natural gas, nitrogen, oxygen, pipe diameters for other gases on request
pipe diameter min. recommended/max. recommended/max. extended: in diagonal arrangement and for a flow velocity of 15 m/s

Shear Wave Transducers (zone 2)

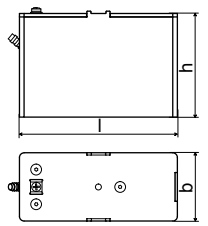
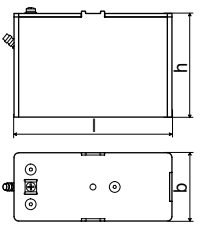
technical type		GDG1NH1	GDK1NH1
order code		GSG-NA2NL	GSK-NA2NL
transducer frequency		MHz 0.2	0.5
medium pressure¹			
min. extended min.		bar metal pipe: 20 bar metal pipe: 30 plastic pipe: 1	metal pipe: 20 metal pipe: 30 plastic pipe: 1
inner pipe diameter d²			
min. extended		mm 250	70
min. recommended		mm 380	80
max. recommended		mm 810	500
max. extended		mm 1100	720
pipe wall thickness			
min.		mm 14	5
max.		mm -	-
material			
housing		PEEK with stainless steel cap and transducer shoe 304 (1.4301)	PEEK with stainless steel cap and transducer shoe 304 (1.4301)
contact surface		PEEK	PEEK
degree of protection according to IEC/ EN 60529		IP65	IP65
transducer cable			
type		1699	1699
length		m 5	5
dimensions			
length l		mm 136.5	136.5
width b		mm 59	59
height h		mm 90.5	90.5
dimensional drawing			
ambient temperature			
min.		°C -40	-40
max.		°C +130	+130
temperature compensation		x	x
explosion protection			
category		gas: 3G dust: 2D	gas: 3G dust: 2D
EPL		Gc Db	Gc Db
zone		2 21	2 21
explosion protection temperature (pipe surface)			
min.		°C -55	-55
max.		°C +190	+190
marking		CE 0637 Ex nA IIC T6...T2 Gc X Ex tb IIIC TX Db II3G II2D	CE 0637 Ex nA IIC T6...T2 Gc X Ex tb IIIC TX Db II3G II2D
certification ATEX		IBExU10ATEX1163 X	IBExU10ATEX1163 X
certification IECEx		IECEx IBE 12.0005X	IECEx IBE 12.0005X
type of protection		gas: non sparking dust: protection by enclosure	gas: non sparking dust: protection by enclosure

¹ depending on application, typical absolute value for natural gas, nitrogen, compressed air

² shear wave transducer:

typical values for natural gas, nitrogen, oxygen, pipe diameters for other gases on request
pipe diameter min. recommended/max. recommended/max. extended: in diagonal arrangement and for a flow velocity of 15 m/s

Shear Wave Transducers (zone 2)

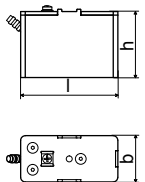
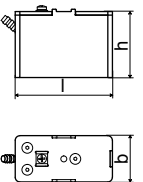
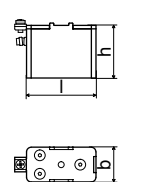
technical type		GDM2NH1	GDP2NH1	GDQ2NH1
order code		GSM-NA2NL	GSP-NA2NL	GSQ-NA2NL
transducer frequency		MHz 1	2	4
medium pressure¹				
min. extended min.	bar	metal pipe: 20 metal pipe: 30 plastic pipe: 1	metal pipe: 20 metal pipe: 30 plastic pipe: 1	metal pipe: 20 metal pipe: 30 plastic pipe: 1
inner pipe diameter d²				
min. extended	mm	30	15	6
min. recommended	mm	40	20	10
max. recommended	mm	80	40	20
max. extended	mm	120	60	30
pipe wall thickness				
min.	mm	2.5	1.5	1
max.	mm	-	-	-
material				
housing		PEEK with stainless steel cap and transducer shoe 304 (1.4301)	PEEK with stainless steel cap and transducer shoe 304 (1.4301)	PEEK with stainless steel cap and transducer shoe 304 (1.4301)
contact surface		PEEK	PEEK	PEEK
degree of protection according to IEC/EN 60529		IP65	IP65	IP65
transducer cable				
type		1699	1699	1699
length	m	4	4	3
dimensions				
length l	mm	84	84	70
width b	mm	40	40	30
height h	mm	59	59	47.5
dimensional drawing				
ambient temperature				
min.	°C	-40	-40	-40
max.	°C	+130	+130	+130
temperature compensation		x	x	x
explosion protection				
category		gas: 3G dust: 2D	gas: 3G dust: 2D	gas: 3G dust: 2D
EPL		Gc Db	Gc Db	Gc Db
zone		2 21	2 21	2 21
explosion protection temperature (pipe surface)				
min.	°C	-55	-55	-55
max.	°C	+190	+190	+190
marking		CE 0637 II3G II2D Ex nA IIC T6...T2 Gc X Ex tb IIIC TX Db	CE 0637 II3G II2D Ex nA IIC T6...T2 Gc X Ex tb IIIC TX Db	CE 0637 II3G II2D Ex nA IIC T6...T2 Gc X Ex tb IIIC TX Db
certification ATEX		IBExU10ATEX1163 X	IBExU10ATEX1163 X	IBExU10ATEX1163 X
certification IECEx		IECEX IBE 12.0005X	IECEX IBE 12.0005X	IECEX IBE 12.0005X
type of protection		gas: non sparking dust: protection by enclosure	gas: non sparking dust: protection by enclosure	gas: non sparking dust: protection by enclosure
remark				on request

¹ depending on application, typical absolute value for natural gas, nitrogen, compressed air

² shear wave transducer:
typical values for natural gas, nitrogen, oxygen, pipe diameters for other gases on request
pipe diameter min. recommended/max. recommended/max. extended: in diagonal arrangement and for a flow velocity of 15 m/s

Shear Wave Transducers (zone 2, extended temperature range)

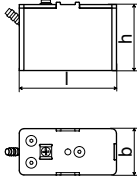
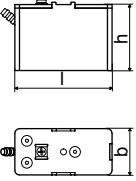
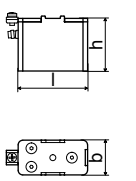
technical type		GDM2EH5		GDP2EH5		GDQ2EH5	
order code		GSM-EA2NL		GSP-EA2NL		GSQ-EA2NL	
transducer frequency		MHz	1	2	4		
medium pressure¹							
min. extended min.		bar	metal pipe: 20 metal pipe: 30 plastic pipe: 1	metal pipe: 20 metal pipe: 30 plastic pipe: 1	metal pipe: 20 metal pipe: 30 plastic pipe: 1		
inner pipe diameter d²							
min. extended		mm	30	15	6		
min. recommended		mm	40	20	10		
max. recommended		mm	80	40	20		
max. extended		mm	120	60	30		
pipe wall thickness							
min.		mm	2.5	1.5	1		
max.		mm	-	-	-		
material							
housing			PI with stainless steel cap and transducer shoe 304 (1.4301)	PI with stainless steel cap and transducer shoe 304 (1.4301)	PI with stainless steel cap and transducer shoe 304 (1.4301)		
contact surface			PI	PI	PI		
degree of protection according to IEC/ EN 60529			IP56	IP56	IP56		
transducer cable							
type			6111	6111	6111		
length		m	4	4	3		
dimensions							
length l		mm	84	84	70		
width b		mm	40	40	30		
height h		mm	59	59	47.5		
dimensional drawing							
ambient temperature							
min.		°C	-30	-30	-30		
max.		°C	+200	+200	+200		
temperature compensation			x	x	x		
explosion protection							
category			gas: 3G dust: 2D	gas: 3G dust: 2D	gas: 3G dust: 2D		
EPL			Gc Db	Gc Db	Gc Db		
zone			2 21	2 21	2 21		
ATEX / IECEx explosion protection temperature (pipe surface)							
min.		°C	-45	-45	-45		
max.		°C	+235	+235	+235		
marking			CE 0637 Ex II3G II2D Ex nA IIC T6...T2 Gc X Ex tb IIIA TX Db	CE 0637 Ex II3G II2D Ex nA IIC T6...T2 Gc X Ex tb IIIA TX Db	CE 0637 Ex II3G II2D Ex nA IIC T6...T2 Gc X Ex tb IIIA TX Db		
certification ATEX			IBExU10ATEX1163 X	IBExU10ATEX1163 X	IBExU10ATEX1163 X		
certification IECEx			IECEX IBE 12.0005X	IECEX IBE 12.0005X	IECEX IBE 12.0005X		
type of protection			gas: non sparking dust: protection by enclosure	gas: non sparking dust: protection by enclosure	gas: non sparking dust: protection by enclosure		
remark					on request		

¹ depending on application, typical absolute value for natural gas, nitrogen, compressed air

² shear wave transducer:

typical values for natural gas, nitrogen, oxygen, pipe diameters for other gases on request

pipe diameter min. recommended/max. recommended/max. extended: in diagonal arrangement and for a flow velocity of 15 m/s

Lamb Wave Transducers (zone 1)

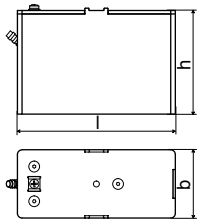
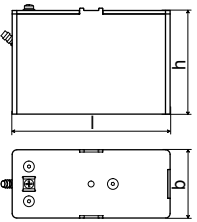
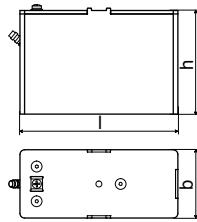
technical type		GRG1NW3	GTG1NW3	GRH1NW3	GTH1NW3	GRK1NW3	GTK1NW3
order code		GLG-NA1NL	GLG-NA1NL/LC	GLH-NA1NL	GLH-NA1NL/LC	GLK-NA1NL	GLK-NA1NL/LC
transducer frequency		0.2		0.3		0.5	
medium pressure¹							
min. extended	bar	metal pipe: 10		metal pipe: 10		metal pipe: 10 (d > 120 mm), 5 (d < 120 mm)	
min.	bar	metal pipe: 15 plastic pipe: 1		metal pipe: 15 plastic pipe: 1		metal pipe: 15 (d > 120 mm), 10 (d < 120 mm) plastic pipe: 1	
inner pipe diameter d²							
min. extended	mm	190		120		60	
min. recommended	mm	220		140		80	
max. recommended	mm	900		600		300	
max. extended	mm	1600		1000		500	
pipe wall thickness							
min.	mm	11		7		4	
max.	mm	23		15		9	
material							
housing		PPSU with stainless steel cap and transducer shoe 304 (1.4301)		PPSU with stainless steel cap and transducer shoe 304 (1.4301)		PPSU with stainless steel cap and transducer shoe 304 (1.4301)	
contact surface		PPSU		PPSU		PPSU	
degree of protection according to IEC/EN 60529		IP65		IP65		IP65	
transducer cable							
type		1699	1699	1699	1699	1699	1699
length	m	5	9	5	9	5	9
dimensions							
length l	mm	136.5		136.5		136.5	
width b	mm	59		59		59	
height h	mm	90.5		90.5		90.5	
dimensional drawing							
ambient temperature							
min.	°C	-40		-40		-40	
max.	°C	+170		+170		+170	
temperature compensation		x		x		x	
explosion protection							
category		gas: 2/3G dust: 2D		gas: 2/3G dust: 2D		gas: 2/3G dust: 2D	
EPL		Gb/Gc Db		Gb/Gc Db		Gb/Gc Db	
zone		1/2 21		1/2 21		1/2 21	
explosion protection temperature (pipe surface)							
min.	°C	-55		-55		-55	
max.	°C	+140		+140		+140	
marking		CE 0637 Ex II2/3G II2D Ex q nA IIC T6...T2 Gb/Gc Ex tb IIIC TX Db		CE 0637 Ex II2/3G II2D Ex q nA IIC T6...T2 Gb/Gc Ex tb IIIC TX Db		CE 0637 Ex II2/3G II2D Ex q nA IIC T6...T2 Gb/Gc Ex tb IIIC TX Db	
certification ATEX		IBExU10ATEX1162 X		IBExU10ATEX1162 X		IBExU10ATEX1162 X	
certification IECEx		IECEx IBE 12.0004X		IECEx IBE 12.0004X		IECEx IBE 12.0004X	
type of protection		gas: powder filling, non sparking dust: protection by enclosure		gas: powder filling, non sparking dust: protection by enclosure		gas: powder filling, non sparking dust: protection by enclosure	

¹ depending on application, typical absolute value for natural gas, nitrogen, compressed air

² Lamb wave transducer:

typical values for natural gas, nitrogen, oxygen, pipe diameters for other gases on request
 pipe diameter min. recommended/max. recommended: in reflection arrangement and for a flow velocity of 15 m/s
 pipe diameter max. extended: in diagonal arrangement and for a flow velocity of 25 m/s

Lamb Wave Transducers (zone 1)

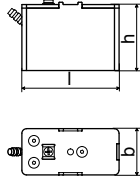
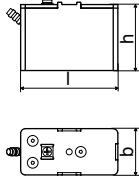
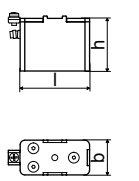
technical type		GRM1NW3	GTM1NW3	GRP1NW3	GTP1NW3	GRQ1NW3	GTQ1NW3
order code		GLM-NA1NL	GLM-NA1NL/LC	GLP-NA1NL	GLP-NA1NL/LC	GLQ-NA1NL	GLQ-NA1NL/LC
transducer frequency		MHz 1		MHz 2		MHz 4	
medium pressure¹							
min. extended min.	bar bar	- metal pipe: 10 (d > 60 mm), 5 (d < 60 mm) plastic pipe: 1		- metal pipe: 10 (d > 35 mm), 5 (d < 35 mm) plastic pipe: 1		- metal pipe: 10 (d > 15 mm), 5 (d < 15 mm) plastic pipe: 1	
inner pipe diameter d²							
min. extended	mm	30		15		7	
min. recommended	mm	40		20		10	
max. recommended	mm	90		50		22	
max. extended	mm	150		70		35	
pipe wall thickness							
min.	mm	2		1		0.5	
max.	mm	5		3		1	
material							
housing		PPSU with stainless steel cap and transducer shoe 304 (1.4301)		PPSU with stainless steel cap and transducer shoe 304 (1.4301)		PPSU with stainless steel cap and transducer shoe 304 (1.4301)	
contact surface		PPSU		PPSU		PPSU	
degree of protection according to IEC/EN 60529		IP65		IP65		IP65	
transducer cable							
type		1699	1699	1699	1699	1699	1699
length	m	4	9	4	9	4	9
dimensions							
length l	mm	84		84		70	
width b	mm	40		40		30	
height h	mm	59		59		47.5	
dimensional drawing							
ambient temperature							
min.	°C	-40		-40		-40	
max.	°C	+170		+170		+170	
temperature compensation		x		x		x	
explosion protection							
category		gas: 2/3G dust: 2D		gas: 2/3G dust: 2D		gas: 2/3G dust: 2D	
EPL		Gb/Gc Db		Gb/Gc Db		Gb/Gc Db	
zone		1/2 21		1/2 21		1/2 21	
explosion protection temperature (pipe surface)							
min.	°C	-55		-55		-55	
max.	°C	+140		+140		+140	
marking		CE 0637 Ex II2/3G II2D Ex q nA IIC T6...T2 Gb/Gc Ex tb IIIC TX Db		CE 0637 Ex II2/3G II2D Ex q nA IIC T6...T2 Gb/Gc Ex tb IIIC TX Db		CE 0637 Ex II2/3G II2D Ex q nA IIC T6...T2 Gb/Gc Ex tb IIIC TX Db	
certification ATEX		IBExU10ATEX1162 X		IBExU10ATEX1162 X		IBExU10ATEX1162 X	
certification IECEx		IECEx IBE 12.0004X		IECEx IBE 12.0004X		IECEx IBE 12.0004X	
type of protection		gas: powder filling, non sparking dust: protection by enclosure		gas: powder filling, non sparking dust: protection by enclosure		gas: powder filling, non sparking dust: protection by enclosure	
remark		on request					

¹ depending on application, typical absolute value for natural gas, nitrogen, compressed air

² Lamb wave transducer:

typical values for natural gas, nitrogen, oxygen, pipe diameters for other gases on request

pipe diameter min. recommended/max. recommended: in reflection arrangement and for a flow velocity of 15 m/s

pipe diameter max. extended: in diagonal arrangement and for a flow velocity of 25 m/s

Lamb Wave Transducers (zone 2)

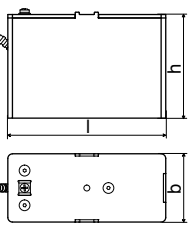
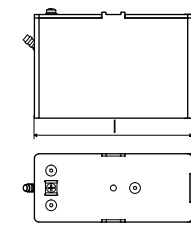
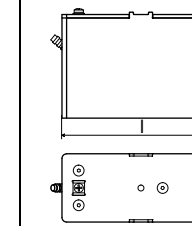
technical type		GRG1NH3	GRH1NH3	GRK1NH3
order code		GLG-NA2NL	GLH-NA2NL	GLK-NA2NL
transducer frequency		MHz 0.2	0.3	0.5
medium pressure¹				
min. extended	bar	metal pipe: 10	metal pipe: 10	metal pipe: 10 (d > 120 mm) 5 (d < 120 mm)
min.	bar	metal pipe: 15 plastic pipe: 1	metal pipe: 15 plastic pipe: 1	metal pipe: 15 (d > 120 mm) 10 (d < 120 mm) plastic pipe: 1
inner pipe diameter d²				
min. extended	mm	190	120	60
min. recommended	mm	220	140	80
max. recommended	mm	900	600	300
max. extended	mm	1600	1000	500
pipe wall thickness				
min.	mm	11	7	4
max.	mm	23	15	9
material				
housing		PPSU with stainless steel cap and transducer shoe 304 (1.4301)	PPSU with stainless steel cap and transducer shoe 304 (1.4301)	PPSU with stainless steel cap and transducer shoe 304 (1.4301)
contact surface		PPSU	PPSU	PPSU
degree of protection according to IEC/EN 60529		IP65	IP65	IP65
transducer cable				
type		1699	1699	1699
length	m	5	5	5
dimensions				
length l	mm	136.5	136.5	136.5
width b	mm	59	59	59
height h	mm	90.5	90.5	90.5
dimensional drawing				
ambient temperature				
min.	°C	-40	-40	-40
max.	°C	+170	+170	+170
temperature compensation		x	x	x
explosion protection				
category		gas: 3G dust: 2D	gas: 3G dust: 2D	gas: 3G dust: 2D
EPL		Gc Db	Gc Db	Gc Db
zone		2 21	2 21	2 21
explosion protection temperature (pipe surface)				
min.	°C	-55	-55	-55
max.	°C	+150	+150	+150
marking		CE 0637 Ex nA IIC T6...T2 Gc X Ex tb IIIC TX Db II3G II2D	CE 0637 Ex nA IIC T6...T2 Gc X Ex tb IIIC TX Db II3G II2D	CE 0637 Ex nA IIC T6...T2 Gc X Ex tb IIIC TX Db II3G II2D
certification ATEX		IBExU10ATEX1163 X	IBExU10ATEX1163 X	IBExU10ATEX1163 X
certification IECEx		IECEX IBE 12.0005X	IECEX IBE 12.0005X	IECEX IBE 12.0005X
type of protection		gas: non sparking dust: protection by enclosure	gas: non sparking dust: protection by enclosure	gas: non sparking dust: protection by enclosure

¹ depending on application, typical absolute value for natural gas, nitrogen, compressed air

² Lamb wave transducer:

typical values for natural gas, nitrogen, oxygen, pipe diameters for other gases on request
 pipe diameter min. recommended/max. recommended: in reflection arrangement and for a flow velocity of 15 m/s
 pipe diameter max. extended: in diagonal arrangement and for a flow velocity of 25 m/s

Lamb Wave Transducers (zone 2)

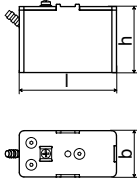
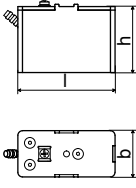
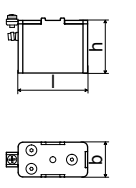
technical type		GRM1NH3	GRP1NH3	GRQ1NH3
order code		GLM-NA2NL	GLP-NA2NL	GLQ-NA2NL
transducer frequency		MHz 1	2	4
medium pressure¹				
min. extended min.	bar	-	-	-
	bar	metal pipe: 10 (d > 60 mm) 5 (d < 60 mm) plastic pipe: 1	metal pipe: 10 (d > 35 mm) 5 (d < 35 mm) plastic pipe: 1	metal pipe: 10 (d > 15 mm) 5 (d < 15 mm) plastic pipe: 1
inner pipe diameter d²				
min. extended	mm	30	15	7
min. recommended	mm	40	20	10
max. recommended	mm	90	50	22
max. extended	mm	150	70	35
pipe wall thickness				
min.	mm	2	1	0.5
max.	mm	5	3	1
material				
housing		PPSU with stainless steel cap and transducer shoe 304 (1.4301)	PPSU with stainless steel cap and transducer shoe 304 (1.4301)	PPSU with stainless steel cap and transducer shoe 304 (1.4301)
contact surface		PPSU	PPSU	PPSU
degree of protection according to IEC/EN 60529		IP65	IP65	IP65
transducer cable				
type		1699	1699	1699
length	m	4	4	3
dimensions				
length l	mm	84	84	70
width b	mm	40	40	30
height h	mm	59	59	47.5
dimensional drawing				
ambient temperature				
min.	°C	-40	-40	-40
max.	°C	+170	+170	+170
temperature compensation		x	x	x
explosion protection				
category		gas: 3G dust: 2D	gas: 3G dust: 2D	gas: 3G dust: 2D
EPL		Gc Db	Gc Db	Gc Db
zone		2 21	2 21	2 21
explosion protection temperature (pipe surface)				
min.	°C	-55	-55	-55
max.	°C	+150	+150	+150
marking		CE 0637 Ex II3G II2D Ex nA IIC T6...T2 Gc X Ex tb IIIC TX Db	CE 0637 Ex II3G II2D Ex nA IIC T6...T2 Gc X Ex tb IIIC TX Db	CE 0637 Ex II3G II2D Ex nA IIC T6...T2 Gc X Ex tb IIIC TX Db
certification ATEX		IBExU10ATEX1163 X	IBExU10ATEX1163 X	IBExU10ATEX1163 X
certification IECEx		IECEx IBE 12.0005X	IECEx IBE 12.0005X	IECEx IBE 12.0005X
type of protection		gas: non sparking dust: protection by enclosure	gas: non sparking dust: protection by enclosure	gas: non sparking dust: protection by enclosure
remark				on request

¹ depending on application, typical absolute value for natural gas, nitrogen, compressed air

² Lamb wave transducer:
typical values for natural gas, nitrogen, oxygen, pipe diameters for other gases on request
pipe diameter min. recommended/max. recommended: in reflection arrangement and for a flow velocity of 15 m/s
pipe diameter max. extended: in diagonal arrangement and for a flow velocity of 25 m/s

Transducer Mounting Fixture

Order Code

1, 2	3	4	5	6	7...9	no. of character		
transducer mounting fixture	transducer	-	measurement arrangement	size	-	fixation	outer pipe diameter	description
VP							portable Variofix	
A							all transducers	
		D					reflection arrangement or diagonal arrangement	
		R					reflection arrangement	
				M		medium		
						C	chains	
						N	without fixation	
						055	10...550 mm	
example								
VP	A	-	D	M	-	C	055	portable Variofix and chains
		-			-			

portable Variofix VP and chains

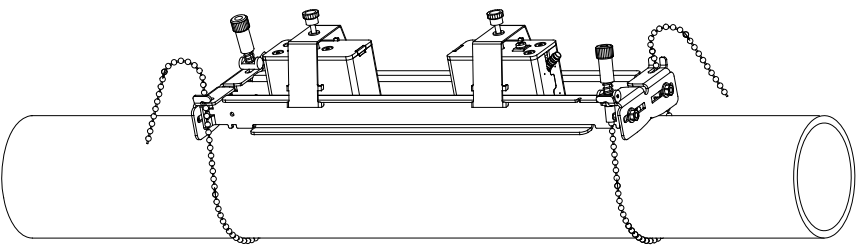

material: stainless steel 304 (1.4301), 301 (1.4310), 303 (1.4305)
 dimensions: 414 x 94 x 76 mm
 chain length: 2 m

Coupling Materials for Transducers

normal temperature range (4th character of transducer order code = N)		extended temperature range (4th character of transducer order code = E)	
< 100 °C	< 170 °C	< 150 °C	< 200 °C
coupling compound type N	coupling compound type E	coupling compound type E	coupling compound type E or H

Technical Data

type	order code	ambient temperature °C	material
coupling compound type N	990739-1	-30...+130	mineral grease paste
coupling compound type E	990739-2	-30...+200	silicone paste
coupling compound type H	990739-3	-30...+250	fluoropolymer paste

Damping Mats (optional)

Damping mats will be used for the gas measurement to reduce acoustic noise influences on the measurement.

Transducer damping mats will be installed below the transducers.

Pipe damping mats will be installed at reflection points, e.g. flange, weld.

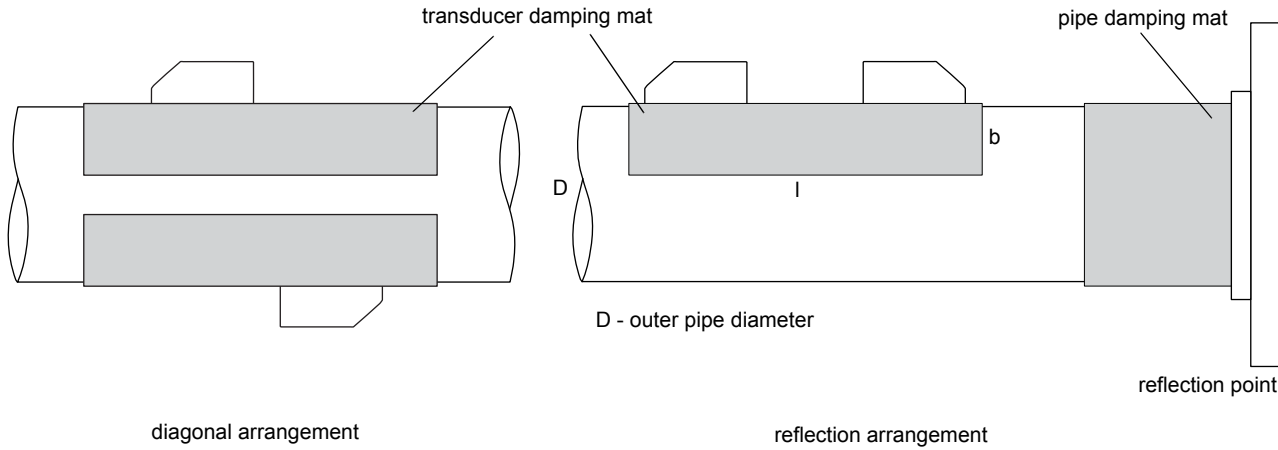

Selection of Damping Mats

type	description	outer pipe diameter mm	dimensions l x b x h mm	transducer frequency					technical type	ambient temperature °C	remark
				G	H	K	M	P			
transducer damping mat											
D	for temporary installation (multiple use), fixed with coupling compound	< 80	450 x 115 x 0.5	-	-	-	x	x	D20S3	-25...+60	
		≥ 80	900 x 230 x 0.5	-	-	x	x	-	D20S2		
			900 x 230 x 1.3	x	x	-	-	-	D50S2		
pipe damping mat											
A	for temporary installation (multiple use), fixed with coupling compound	< 300	300 x 115 x 0.5	x	x	x	x	x	A20S4	-25...+60	for quantity see table below
B	self-adhesive	≥ 300	l x 100 x 0.9	x	x	x	x	x	B35R2	-35...+50	l - see table below

Quantity for Pipe Damping Mat - type A

(depending on the outer pipe diameter)

outer pipe diameter D mm	transducer frequency	
	G, H	K, M, P
100	12	6
200	24	12
300	32	16

Length of Pipe Damping Mat - type B

(length l depending on transducer frequency and outer pipe diameter)

outer pipe diameter D mm	transducer frequency	
	G, H m	K, M, P m
300	12	6
500	32	16
1000	126	63

Connection Systems

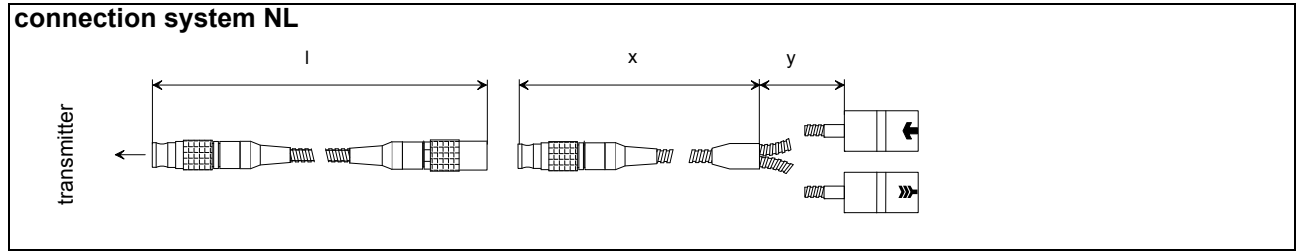

transducer frequency (3d character of transducer order code)		G, H, K			M, P			Q			S			
N L	cable length	m	x 2	y 3	l ≤ 10	x 2	y 2	l ≤ 10	x 2	y 1	l ≤ 10	x 1	y 1	l ≤ 10
	cable length (option LC)	m	2	7	≤ 10	7	2	≤ 10	8	1	≤ 10	-	-	-

x, y - transducer cable length
l - max. length of extension cable

Transducer Cable

Technical Data

		transducer cable		extension cable
type		1699	6111	1750
standard length	m	see table above		5 10
ambient temperature	°C	-55...+200	-100...+225	< 80
sheath				
material		stainless steel 304 (1.4301)	stainless steel 304 (1.4301)	stainless steel 304 (1.4301)
outer diameter	mm	8	8	9
cable jacket				
material		PTFE	PFA	PE
outer diameter	mm	2.9	2.7	6
thickness	mm	0.3	0.5	0.5
color		brown	white	black
shield		x	x	x

Clamp-on Temperature Probe (optional)

Technical Data

technical type		PT12N	PT12N	PT12F	PT12F	
order code		670415-1	670414-1	670415-2	670414-2	
design		short response time				
type		Pt100	2x Pt100 matched according to EN 1434-1	Pt100	2x Pt100 matched according to EN 1434-1	
connection		4-wire		4-wire		
measuring range		-30...+250		-50...+250		
accuracy T		$\pm(0.15\text{ °C} + 2 \cdot 10^{-3} \cdot T\text{ [°C]})$, class A		$\pm(0.15\text{ °C} + 2 \cdot 10^{-3} \cdot T\text{ [°C]})$, class A		
accuracy ΔT		-	$\leq 0.1\text{ K}$ ($3\text{ K} < \Delta T < 6\text{ K}$), more corresponding to EN 1434-1	-	$\leq 0.1\text{ K}$ ($3\text{ K} < \Delta T < 6\text{ K}$), more corresponding to EN 1434-1	
response time		50		8		
housing		aluminum		PEEK, stainless steel 304 (1.4301), copper		
degree of protection according to IEC/EN 60529		IP66		IP66		
weight (without connector)		kg	0.25	0.5	0.32	0.64
fixation		clamp-on		clamp-on		
accessories						
thermal conductivity paste 200 °C		x		x		
thermal conductivity foil 250 °C		x		x		
plastic protection plate, insulation foam		-		x		
dimensions						
length l		mm	15	14		
width b		mm	15	30		
height h		mm	20	27		
dimensional drawing		A		B		

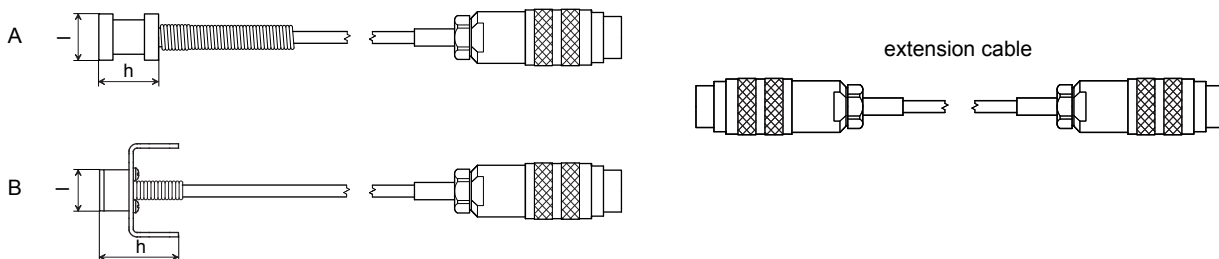

Connection

Temperature Probe

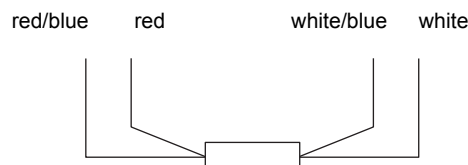

Connector

pin	cable of temperature probe	extension cable
1	white/blue	blue
2	red/blue	gray
3, 4, 5	not connected	
6	red	red
7	white	white
8	not connected	

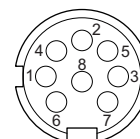

Cable

		cable of temperature probe	extension cable
type		4 x 0.25 mm ² black or white	LIYCY 8 x 0.14 mm ² gray
standard length		m	3
max. length		m	-
cable jacket		PTFE	PVC

Wall Thickness Measurement (optional)

The pipe wall thickness is an important pipe parameter which has to be determined exactly for a good measurement. However, the pipe wall thickness often is unknown.

The wall thickness probe can be connected to the transmitter instead of the flow transducers and the wall thickness measurement mode is activated automatically.

Acoustic coupling compound is applied to the wall thickness probe which then is placed firmly on the pipe. The wall thickness is displayed and can be stored directly in the transmitter.

Technical Data

technical type		DWR1NZ7
measuring range ¹	mm	1...250
resolution	mm	0.01
accuracy		1 % ± 0.1 mm
medium temperature	°C	-20...+200, short-time peak max. 500
explosion protection		-
cable		
type		2616
length	m	1.5

¹ The measuring range depends on the attenuation of the ultrasonic signal in the pipe. For strongly attenuating plastics (e.g. PFA, PTFE, PP) the measuring range is smaller.

Cable

type		2616
ambient temperature	°C	<200
cable jacket		
material		FEP
outer diameter	mm	5.1
color		black
shield		x

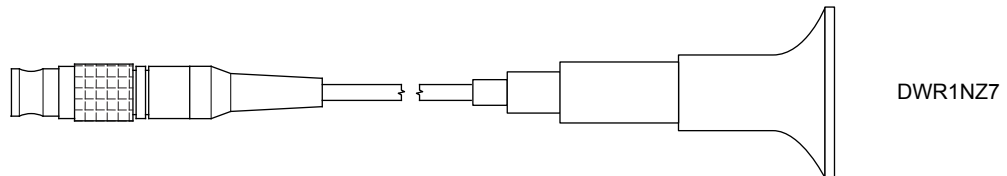



FLEXIM GmbH
Wolfener Str. 36
12681 Berlin
Germany
Tel.: +49 (30) 93 66 76 60
Fax: +49 (30) 93 66 76 80

internet: www.flexim.com
e-mail: info@flexim.com

Subject to change without notification. Errors excepted.
FLUXUS® is a registered trademark of FLEXIM GmbH.

TSFLUXUS_G608xx-A2V1-5-2EN_Leu, 2014-03-20